

water in motion



3 Garden hose fittings + valves



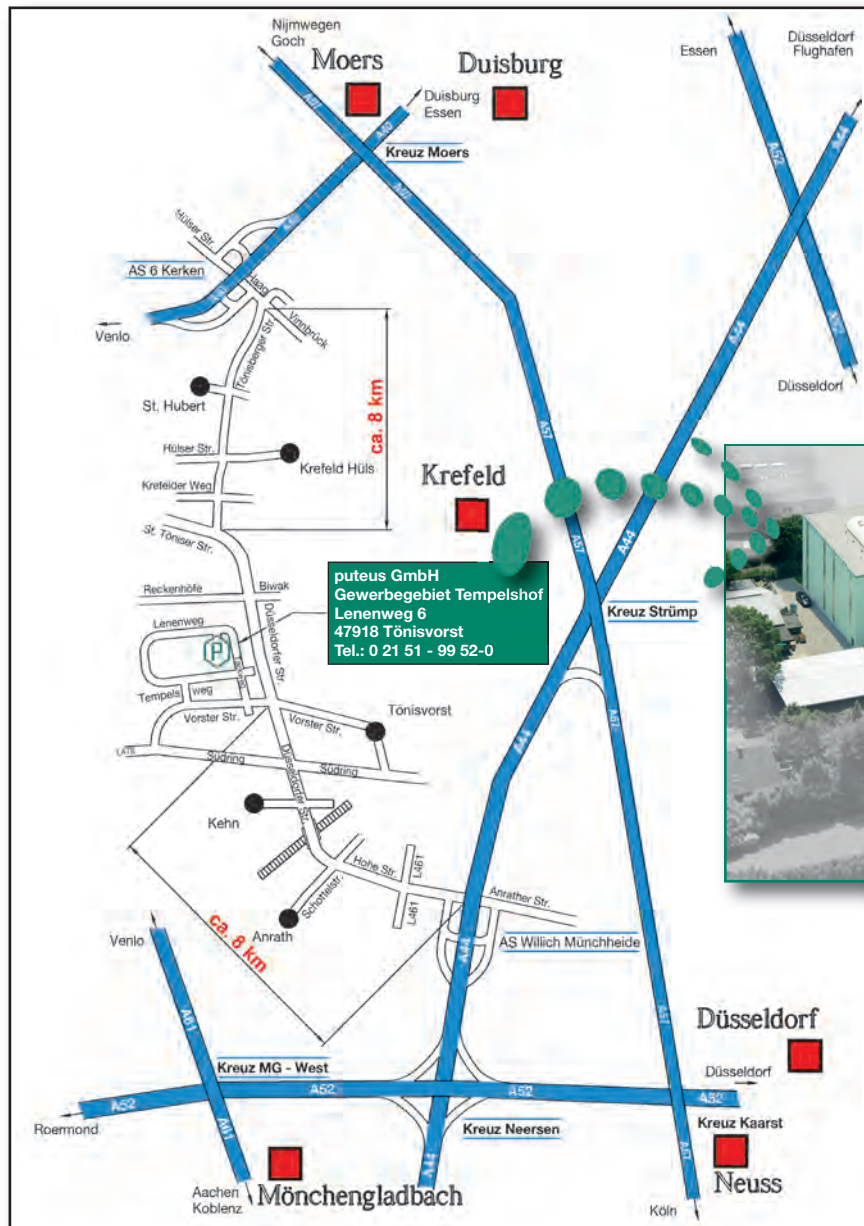

How to find us?

How to reach us?

Phone: +49-(0) 2151-9952-0 • Fax: +49-(0)2151-9952-99 • e-mail: info@puteus.de



Distance Tönisvorst – airport

-  Düsseldorf 34 km
-  Weeze 66 km
-  Köln/Bonn 71 km
-  Dortmund 91 km

Contact:

Prefix:
+49(0)2151...

Phone	Fax	E-Mail
9952-22	9952-25	h-degruyter@puteus.de
9952-42	9952-45	p-degruyter@puteus.de
9952-42	9952-45	b-brender@puteus.de
9952-50	9952-55	verkauf@puteus.de
9952-52	9952-55	verkauf@puteus.de
9952-60	9952-55	export@puteus.de
9952-12	9952-15	vertrieb@puteus.de
9952-22	9952-24	finanzen@puteus.de
9952-23	9952-24	finanzen@puteus.de

Management

Hans de Gruyter
Purchasing/Finance
Peter de Gruyter
Distribution

Management Assistance

Sales Manager

Sales Department, Germany

Sales Department, Export

Customer Service and order processing

Accounting Department

Import/Export customs clearance

Puteus GmbH, a manufacturing and distributing company, was founded in 1979 by the parents of the present share holders. Puteus experienced a rapid development - from a supplier for products of the gardening and irrigation sector to a large range of the heating, plumbing- and garden components.



The company is based in Tönisvorst



The high-bay warehouse

Our modern warehouse with a capacity of 10.000 pallets and a picking area for further 3.000 pallets allows short delivery times.

In addition to our standard product range we also design and manufacture lots of OEM products for the sanitary and heating industries in production sites spread all over the world. Many of our products meet the different requirements and regulations, e.g. DVGW, PA-certificates, KIWA, ACS or SVGW.



Whether the customer orders full pallet units ...



...we supply individually and promptly.

Qualified employees in all areas of the company use their skills to satisfy your individual needs – from the standard fitting to the construction of customer-specific items.

In our German production sites we own different production lines, electroplating and modern robot plants, tool- and mould making as well as turnery and metal-work departments.



...or wishes smaller packing units ...

The owner-managed family company **puteus GmbH** was the starting point for a group of companies of, today, about 250 employees. It has set itself the target of combining optimal quality and service and -at the same time- responding flexibly and promptly to the changes in the market. We are distinguished both by continuous development of knowledge and quality improvements of our products that are in the interest of our customers as well as commitment and curiosity for what is new and feasible.



Ready for shipment.

These following companies also belong to the de Gruyter-Stach-Group



► **Schlösser Armaturen GmbH & Co. KG**

Im Dohm 3 | D-57462 Olpe
 Phone: +49-27 61-607-0 | Fax: +49-27 61-607-10
 E-Mail: info@schloesser-armaturen.de

Commercial register entry:
 AG Siegen | HRA 8076 | UST-IDNR DE 814 779 086 | Sitz Olpe
 CEO: Henning de Gruyter | Olaf Stach

**Water and heating connection valves
 bib taps · appliance connection fittings
 heating fittings · water meters
 state-certified calibration unit for water meters**



► **Heinrich Schulte GmbH & Co. KG**

Grünlandweg 11 | D-58640 Iserlohn
 Phone: +49-23 71-90 90-0 | Fax: +49-23 71-90 90-99
 E-Mail: info@heinrichschulte.com

Commercial register entry:
 AG Iserlohn | HRA 2276
 UST-IDNR DE 233 202 839 | Sitz Iserlohn
 CEO: Henning de Gruyter | Olaf Stach

Exclusive sanitary taps and mixers



► **Heinrich Schulte GmbH & Co. KG**

Giesestrasse 30 | D-58636 Iserlohn
 Phone: +49-23 71-90 90-0 | Fax: +49-23 71-90 90-99
 E-Mail: info@heinrichschulte.com

Commercial register entry:
 AG Iserlohn | HRA 2276
 UST-IDNR DE 233 202 839 | Sitz Iserlohn
 CEO: Henning de Gruyter | Olaf Stach

Exclusive sanitary taps and mixers



3



Table of contents

Connectors

Page 6



Hose fittings + hose tails

Page 9

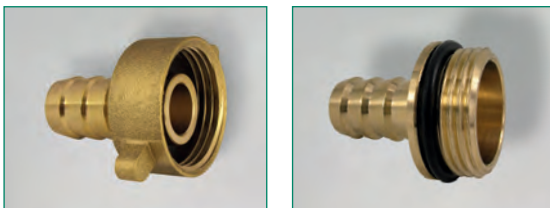

Hose clamps + heavy duty clamps

Page 21



Clamp connections for brass/polypropylene compression fittings Page 33



Quick-connect hose fittings, brass

Page 40

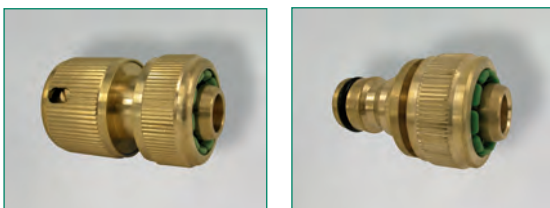

Table of contents

Express couplings, brass/stainless steel + couplings „Storz“ **Page 45**



Spray nozzles **Page 63**



Taps **Page 70**



Ball bibcocks **Page 79**



IBC-Adapter with accessories **Seite 86**



3-way coupling, brass quick-connector system



All pages plug-in coupling

Item-No.:	Item-No.:	Length:		Packing unit:
		L1	L2	
plain	chrome-plated			
33052 0	33057 5	62	72	10/110

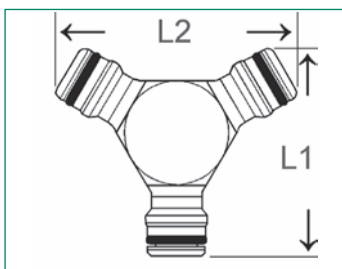

Twin tap connector for 2 operating watering accessoires, brass quick-connector system

1 x female thread, 2 x couplings



Item-No.:	Item-No.:	Connect.:	Length:		Packing unit:
			L1	L2	
plain	chrome-plated				
53312 9	53317 4	3/4" IG	90	99,5	2/40

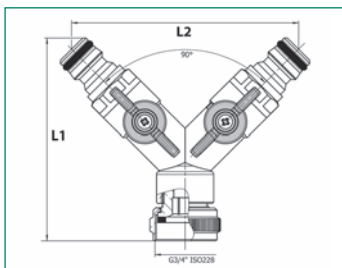

Twin tap connector for 2 operating watering accessoires, brass quick-connector system

3 x couplings



Item-No.:	Item-No.:	Length:		Packing unit:
		L1	L2	
plain	chrome-plated			
53313 6	53318 1	104	99,5	2/40

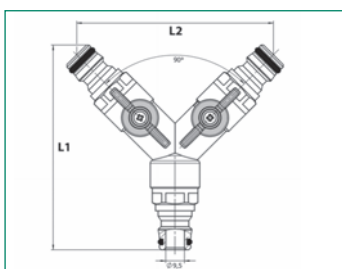

Y-connector with two ball valves, brass

Disposals individually lockable by ball valves, 2 x male threads, 1 x female threaded

Item-No.:	Item-No.:	Connec.:	Length:		Packing unit:
			L1	L2	
plain	chrome-plated				
53302 2	53307 5	3/4"	78	70	6/48

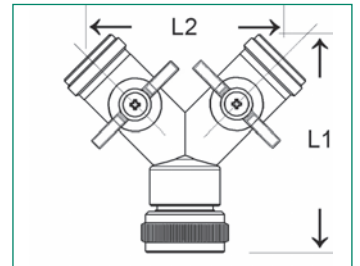

Y-connector with two ball valves, brass

Disposals individually lockable by ball valves, 2 x male threads, 1 x female threaded

Item-No.:	Item-No.:	Connec.:	Length:		Packing unit:
			L1	L2	
plain	chrome-plated				
53302-1"		1"	95	112	2/20

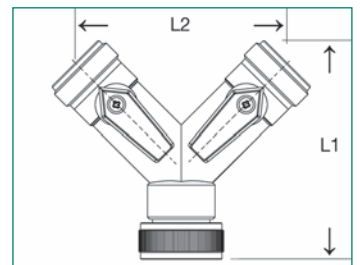

Y-connector with two valve bonnets, brass

Input 3/4" female threaded union nut (rotatable), two outlets 3/4" male threads, disposals individually lockable by valve bonnets

Item-No.:	Connection:	Length:		Packing unit:
		L1	L2	
34995 9	3/4"	73	75	5/30

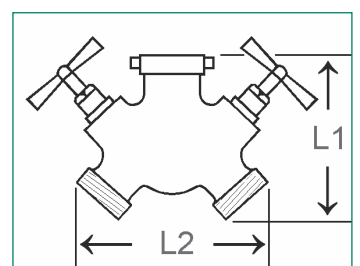

Y-connector with express couplings, brass



With hose connector, disposals individually lockable by upper valve parts

Item-No.:	Nominal diameter	Length:		Pack. unit:
		L1	L2	
34996 6	15	124	123	5/60

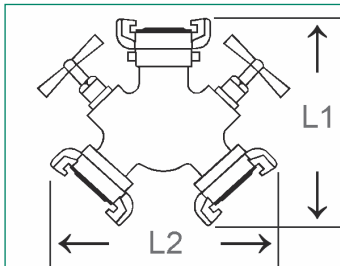

Y-connector with two valve bonnets and two hose tails, brass



With hose tails, disposals individually lockable, rotatable connection thread 3/4" female thread

Item-No.:	Connection:	Length:		Packing unit:
		L1	L2	
34994 2	1/2"	100	115	5/60

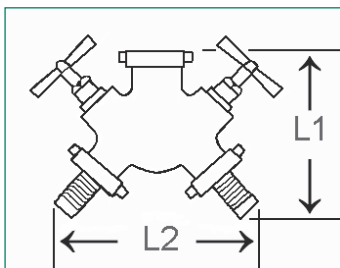

2/3 hose connector, brass

Item-No.: plain	Item-No.: chrome-plated	Spout:	Thread:	Length:		Packing unit: plain	Packing unit: chrome-plated	Replace. seal NBR P. u.: 100
				L1	L2			
34110 6	-	3/8"	3/8"	34	22	25/550	-	33920-KTW
34100 7	35100 6	3/8"	1/2"	35	23,5	25/550	25/450	-
34125 0	35125 9	3/8"	3/4"	35,5	23,3	25/350	25/350	34125-KTW
34101 4	35101 3	1/2"	3/4"	36	23,8	25/350	25/350	33921-KTW
34107 6	-	5/8"	1/2"	36	24,5	25/400	-	33927-KTW
34106 9	-	5/8"	3/4"	37,8	25,6	25/400	-	33926-KTW
34102 1	35102 0	3/4"	1"	39,5	26,5	25/250	25/200	33922-KTW
34103 8	-	1"	1 1/4"	53	35	10/120	-	33923-KTW
34104 5	-	1 1/4"	1 1/2"	59,5	40	10/ 60	-	33924-KTW
34111 3	35111 2	1/2"	1/2"	36	24,5	25/400	25/400	33931-KTW
34112 0	35112 9	3/4"	3/4"	39,5	27,3	25/350	25/300	33932-KTW
34113 7	35113 6	1"	1"	45,5	32,5	25/150	-	33933-KTW
34114 4	-	1 1/4"	1 1/4"	58	40	10/ 70	-	34114-KTW
34115 1	-	1 1/2"	1 1/2"	63	43,5	10/ 60	-	34115-KTW
34105 2	-	1 1/2"	2"	85,5	60	10/ 50	-	-
34116 8	-	2"	2"	84,5	59	5/ 30	-	34116-KTW
34121 2	35121 1	1/2"	1"	41,5	28,5	25/200	25/200	34121-KTW
34122 9	-	1/2"	1 1/4"	41,5	23,5	-/-	-	34122-KTW

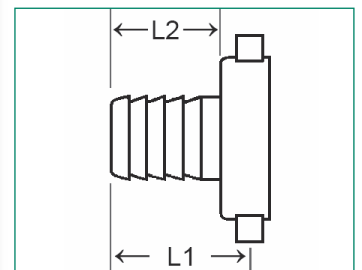

For use in the sanitary area

Female hose tails with knurled nut

Item-No.:	Spout:	Thread:	Length:		Packing unit:
			L1	L2	
2-pieces, brass sheet, chrome-plated, with knurled nut					
35081-K taper joint	1/2"	3/4"	31,5	22,5	50/ 600
35082-K taper joint	3/4"	1"	33,5	23,5	50/ 900
2-pieces, plastic, chrome-plated, with knurled nut					
35081-KU with O-ring	1/2"	3/4"	34,3	23,3	50/1000
35082-KU flat joint	3/4"	1"	33,5	22,5	50/ 900
2-pieces, forged brass, chrome-plated, with knurled nut					
35081 8 flat joint	1/2"	3/4"	31,5	22,5	50/ 600
35082 5 flat joint	3/4"	1"	33,5	23,5	50/ 900
35119 8 flat joint	1/2"	M22/1	34,5	23	25/ 400
2-pieces, brass sheet, plain, with knurled nut					
35081-K-52141	1/2"	3/4"	31,5	22,5	50/1500
35082-K-52142	3/4"	1"	33,5	23,5	50/ 900
2-pieces, plastic, plain, with knurled nut					
35081-KU-52141	1/2"	3/4"	31,5	22,5	50/1500
35082-KU-52142	3/4"	1"	33,5	23,5	50/ 900

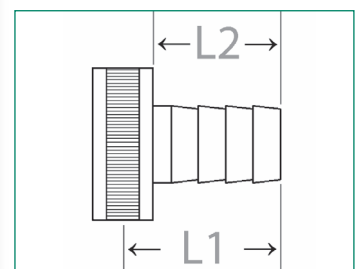

3/3 hose connector, brass

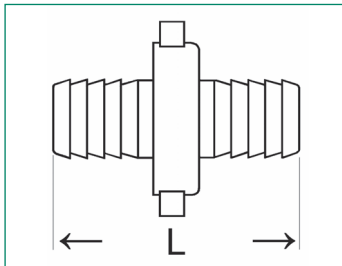
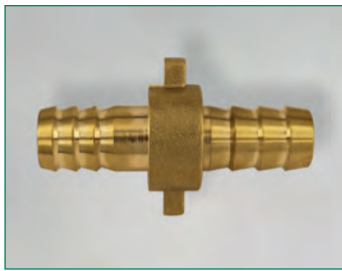

Flat sealing, including NBR seal, hot-pressed

Item-No.:	Connection: Spout	Connection: Thread	Length: L	Packing unit:
34131 1	1/2"	3/4"	60	25/ 250
34180 9	3/8"	1/2"	56,5	10/ 250
34137 3	5/8"	1/2"	60	25/ 250
34136 6	5/8"	3/4"	66	25/ 200
34132 8	3/4"	1"	69	25/ 125
34133 5	1"	1 1/4"	86	10/ 60
34134 2	1 1/4"	1 1/2"	105	4/ 40
34181 6	1/2"	1/2"	60	25/ 250
34182 3	3/4"	3/4"	66,5	25/ 150
34183 0	1"	1"	51	10/ 100
34184 7	1 1/4"	1 1/4"	101	10/ 50
34185 4	1 1/2"	1 1/2"	109,5	5/ 40

3/3 hose connector, brass, reduced

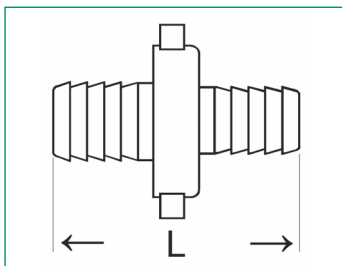
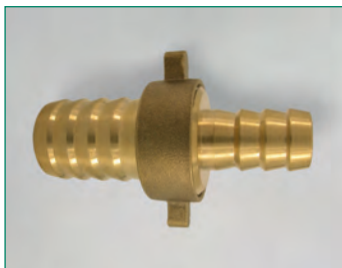

Flat sealing, including NBR seal, hot-pressed

Item-No.:	Connection: Spout	Connection: Thread	Length: L	Packing unit:
34130 4	3/4" x 1/2"	3/4"	64	25/ 200

2/3 elbow hose connector, brass

Flat sealing, including NBR seal, hot-pressed

Item-No.: plain	Item-No.: chrome plated	Con.: Spout	Con.: Thread	Length:		Packing unit: plain	Packing unit: chrome plated
				L1	L2		
34190 8	35190 7	3/8"	1/2"	41,25	25,75	25/300	-
34196 0	35196 9	3/8"	3/4"	41,25	28,75	25/250	25/200
34191 5	35191 4	1/2"	3/4"	41,25	25,75	25/250	-
34192 2		3/4"	1"	48,25	25,75	25/150	-
34195 3		1/2"	1/2"	43,75	28,75	25/300	-
as before, but with hexagon nut							
34193 9		3/8"	1/2"	41,25	28,75	25/300	-

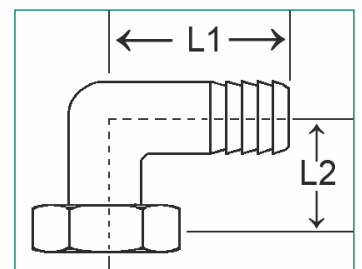
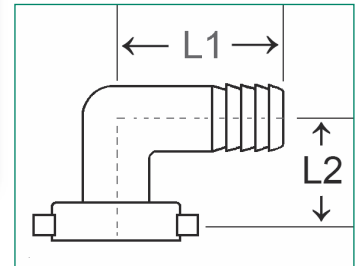

1/3 Male hose connector, brass

Brass, hot-pressed, beaded without O-ring

Item-No.:	Connection: spout	Connection: male thread	Length: L	Packing unit:
34169 4	1"	3/4"	45	25/250

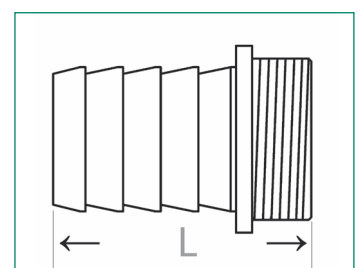
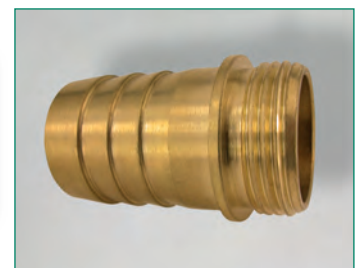

1/3 male hose connector with bead and NBR-O-ring, brass

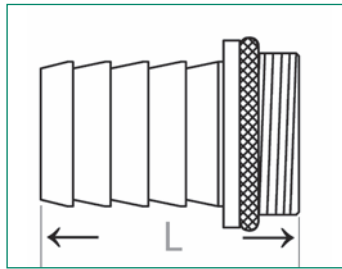
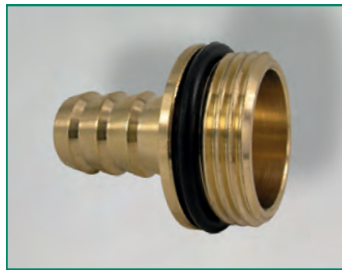

Including NBR seal, hot-pressed

Item-No.:	Connection: Spout	Conne.: Thread	Length: L	Packing unit:	Item-No.: Replacement- O-ring Pack. unit: 100
34161 8	1/2"	3/4"	36	25/400	-
34160 1	1/2"	1"	38	25/250	-
34162 5	3/4"	1"	41	25/300	-
34163 2	1"	1 1/4"	47	25/ 150	-
34164 9	1 1/4"	1 1/2"	55,5	10/ 110	-
34171 7	1/2"	1/2"	32	25/650	33941 7
34172 4	3/4"	3/4"	40	25/ 350	33942 4
34173 1	1"	1"	46	25/250	33943 1
34174 8	1 1/4"	1 1/4"	55,5	10/ 150	33944 8
34175 5	1 1/2"	1 1/2"	60	9/ 90	-
34176 2	2"	2"	78	4/ 40	-

1/3 Male hose connector, brass

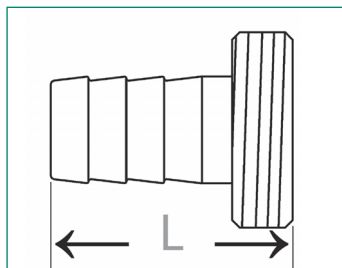

Brass, hot-pressed

Item-No.:	Connection: spout	Connection: male thread	Length: L	Packing unit:
34141 0	1/2"	3/4"	31	25/ 600
34140 2	3/8"	1/2"	30	50/1000
34147 2	5/8"	1/2"	30	25/ 700
34146 5	5/8"	3/4"	34,7	25/ 500
34142 7	3/4"	1"	36	25/ 300
34143 4	1"	1 1/4"	43	10/ 160
34144 1	1 1/4"	1 1/2"	54	10/ 100
34151 9	1/2"	1/2"	30	25/ 700
34152 6	3/4"	3/4"	34	25/ 400
34153 3	1"	1"	43	25/ 200
34154 0	1 1/4"	1 1/4"	54	10/ 130
34155 7	1 1/2"	1 1/2"	58	10/ 80

1/3 Conical male hose tail, brass

Item-No.:	Connection:	Connection:	Length:	Packing unit:
	spout	thread	L	
34985 0	5/8" - 3/4"	3/4"	46	25/550

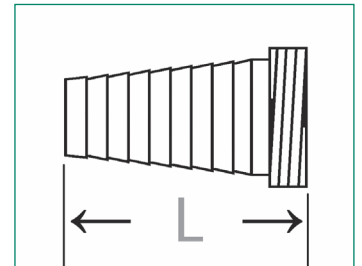
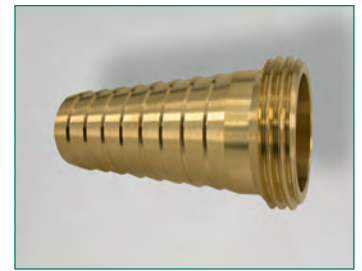

1/3 Male hose tail for bowl clamp fixing, brass

Hot-pressed, cylindrical male thread

Item-No.:	Connect.:	Connect.:	Length:		Packing unit:
			L1	L2	
plain	spout	male			
34762 7	3/4"	G 3/4"	42	62,5	25/100
34763 4	1"	G 1"	42	63	10/ 90
34764 1	1 1/4"	G 1 1/4"	42	70	10/ 60
34765 8	1 1/2"	G 1 1/2"	42	66	10/ 50
34766 5	2"	G 2"	50	78	4/ 40
34768 9	3"	G 3"	68	98	2/ 18
34769 6	4"	G 4"	96	142	1/ 8
Flattened hooks:					
34769-11475	4"	G 4"	96	142	1/ 8

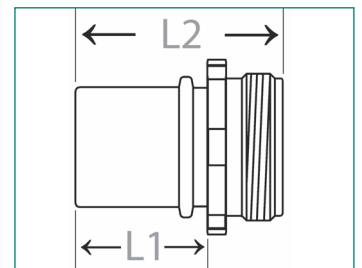

Hose tail for bowl clamp fixing, stainless steel

Cylindrical male thread

Item-No.:	Connect.:	Connect.:	Length:		Packing unit:
			L1	L2	
stainless steel 1.4401	spout	male			
34766-1.4401	2"	G 2"	50	78	4/48
34768-1.4401	3"	G 3"	68	98	2/24
34769-1.4401	4"	G 4"	96	142	1/ 12

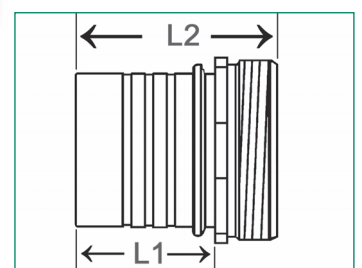

1/3 Male hose tail, brass

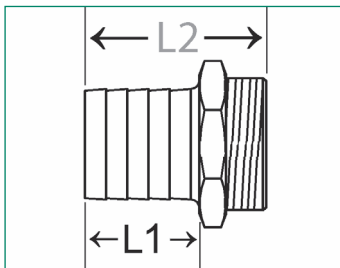
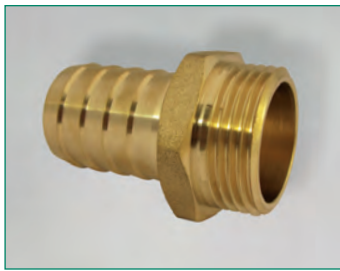

Hot-pressed, plain, clamp fixing, male thread

Item-No.:	Conne.:		Conne.:	Length:		Packing unit:
	plain	spout		mm	L1	
34321 6	1/4"	6	1/4"	25	39	50/1000
34327 8	1/4"	6	1/2"	25	42	25/1000
34323 0	-	8	1/4"	25	39	50/ 750
34325 4	-	8	3/8"	25	39	25/1000
34322 3	-	8	1/2"	25	43	25/1000
34330 8	3/8"	10	1/4"	25	39	50/ 850
34350 6	3/8"	10	3/8"	25	39	25/ 700
34340 7	3/8"	10	1/2"	25	42	25/ 400
34331 5	1/2"	13	3/8"	30	44	25/ 500
34351 3	1/2"	13	1/2"	30	47	25/ 400
34341 4	1/2"	13	3/4"	25	44	25/ 250
34329 2	5/8"	16	1/2"	30	47	25/ 400
34332 2	3/4"	19	1/2"	30	47	25/ 350
34352 0	3/4"	19,5	3/4"	30	49	25/ 200
34342 1	3/4"	19	1"	30	50	25/ 150
34333-10848	1"	25	3/4"	35	50	25/ 250
34353 7	1"	25,5	1"	35	56	25/ 150
34343 8	1"	25	1 1/4"	35	55	10/ 80
34334-10848	1 1/4"	32	1"	38,5	55	25/ 250
34354 4	1 1/4"	32	1 1/4"	39	59	10/ 70
34355 1	1 1/2"	40	1 1/2"	47	71	4/ 48
34366 7	2"	51	2"	54	80	4/ 32
34356-VD	2"	50	2"	69,6	93	4/ 32
34357 5	2 1/2"	64,5	2 1/2"	64	91	4/ 24
34358 2	3"	76	3"	74	111	2/ 24
34358-VD	3"	-	3"	87	114	2/ 12
34359 9	4"	102	4"	100	140	1/ 8

Male hose tail, stainless steel

Stainless steel or equivalent corrosion-resistant steel in accordance with DIN 3017, clamp fixation, hexagon head, male thread

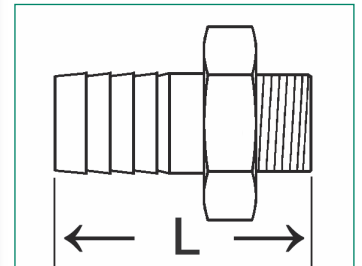

Item-No.:	Item-No.:	Thread:	Length: L	Packing unit:
34350-1.4301	34350-1.4401	3/8" x G 3/8"	-	-
34351-1.4301	34351-1.4401	1/2" x G 1/2"	-	-
34352-1.4301	34352-1.4401	3/4" x G 3/4"	-	-
34353-1.4301	34353-1.4401	1" x G 1"	-	-
34354-1.4301	34354-1.4401	1 1/4" x G 1 1/4"	-	-
34355-1.4301	34355-1.4401	1 1/2" x G 1 1/2"	-	-
34356-1.4301	34356-1.4401	2" x G 2"	-	-
34357-1.4301	34357-1.4401	2 1/2" x G 2 1/2"	-	-
34358-1.4301	34358-1.4401	3" x G 3"	-	-
34359-1.4301	34359-1.4401	4" x G 4"	-	-

Female hose tail, brass, 1 part

Hot-pressed, plain, clamp fixation, hexagon head, female thread

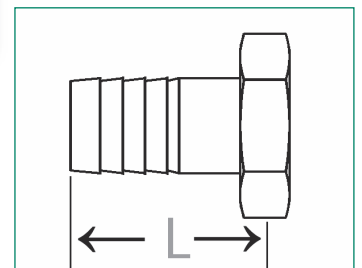

Item-No.:	Connection:	Length: L	Packing unit:
34961 4	∅ 13 mm x 1/2"	40	25/500
34962 1	∅ 20 mm x 3/4"	45	25/250
34963 8	∅ 25 mm x 1"	51,5	25/200
34964 5	∅ 32 mm x 1 1/4"	58	10/100
34965 2	∅ 40 mm x 1 1/2"	60	5/ 120

2/3 Female hose tail, brass

With non-removable hexagon nut

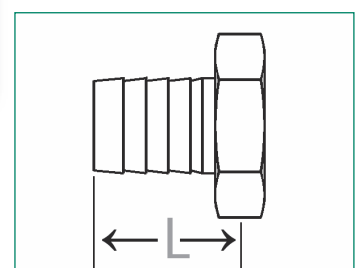

Item-No.:	Connection:	Thread:	Length: L	Packing unit:
34399 5	5/8"	1/2"	41	25/400
34392 6	3/4"	3/4"	45	25/250
34393 3	1"	1"	50	25/150

With removable hexagon nut, 2-pieces

34751 1	1/2"	1/2"	36,5	25/500
34752 8	3/4"	3/4"	41	25/250

3/3 Standpipe fittings, brass

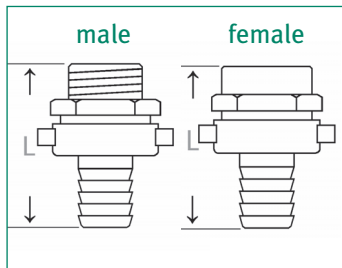
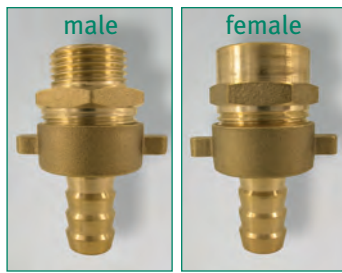

3-pieces, flat sealing, including NBR seal

Item-No.: male	Item-No.: female	Spout:	Con.- thread:	Basic- thread:	Length:		Packing unit: male	Packing unit: female
					L/m	L/f		
34371 1	34381 0	1/2"	1/2"	3/4"	55,5	54	25/200	25/150
34372 8	34382 7	3/4"	3/4"	1"	60	59	25/100	10/100
34373 5	34383 4	1"	1"	1 1/4"	74	53,5	10/ 60	10/ 60
34374 2	34384 1	1 1/4"	1 1/4"	1 1/2"	86	72	10/ 40	-
34375 9	34385 8	1 1/2"	1 1/2"	1 1/2"	114	116	5/ 20	10/ 20
34376 6	-	2"	2"	2"	120	-	10/ 40	-

Hose connector, brass

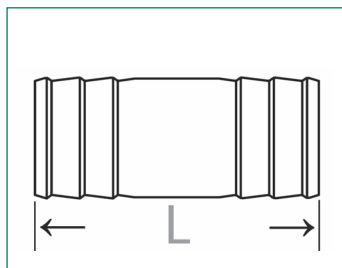

Brass sheet, light duty

Item-No.:	Connection:	Length:	Packing unit:
34090 1	3/8"	50	100/1500
34091 8	1/2"	50	50/ 700
34092 5	3/4"	50	25/ 350
34093 2	1"	60	25/ 175

Hose connector, brass

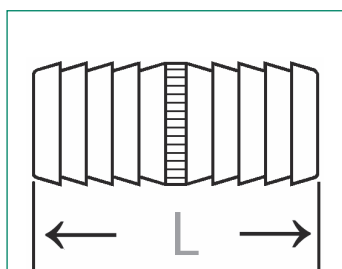

Solid brass

Item-No.:	Connection:	Length:	Packing unit:
34300 1	3/8"	47	50/1000
34301 8	1/2"	48	25/ 650
34309 4	5/8"	49	25/ 450
34302 5	3/4"	53	25/ 350
34303 2	1"	58	25/ 200
34304 9	1 1/4"	63	10/ 140
34305 6	1 1/2"	84	10/ 60
34306 3	2"	90	10/ 40

Hose connector, brass

Solid brass, reduced

Item-No.:	Connection:	Length:	
34311 7	1/2" x 3/4"	55	25/350

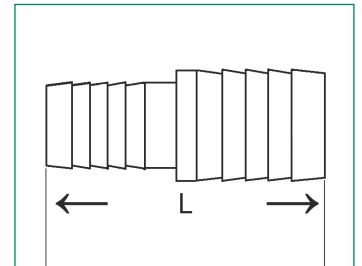

T-hose connector (90°), brass

Solid brass

Item-No.:	Connection:	Length:		Packing unit:
		L1	L2	
34290 5	3/8"	-	-	25/700
34291 2	1/2"	68	43	25/200
34299 8	5/8"	68	43	25/200
34292 9	3/4"	70	44,5	25/150
34293 6	1"	78	52	10/-

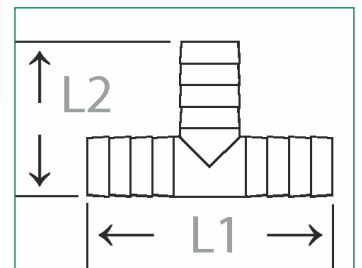

T-hose connector (90°), brass, reducing

Solid brass

Item-No.:	Connection:	Length:		Packing unit:
		L1	L2	
S-2466	13 x 10 x 13 mm	-	-	-/-
S-2533	13 x 13 x 10 mm	-	-	25/350

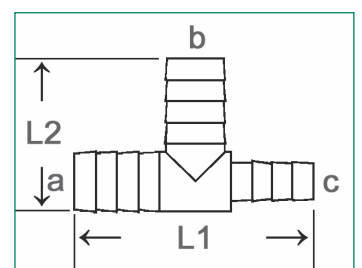

Angle hose connector, brass



Solid brass

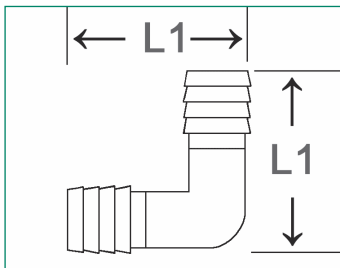

Item-No.:	Connection:	Length:		Packing unit:
		L1		
S-2379	3/8" x 90°	35		25/500
S-2380	1/2" x 90°	38		25/500
S-2381	3/4" x 90°	47		25/250
S-2382	1" x 90°	55		10/150

Y-hose connector (120°), brass



Solid brass

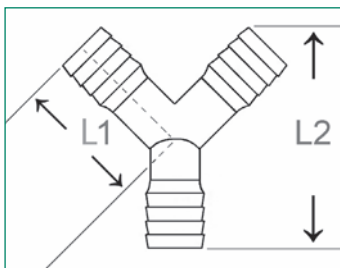

Item-No.:	Connection:	Length:		Packing unit:
		L1	L2	
34982 9	5/8"	48	80	25/150
34983 6	3/4"	48	80	10/100

Y-connector, brass



with 2 spouts and union nut

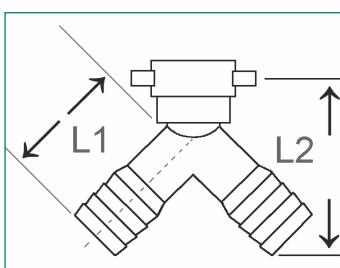

Item-No.:	Connection: spout	Connection: union nut	Length:		Packing unit:
			L1	L2	
34986 7	5/8"	3/4"	48	67,5	25/100
34987 4	3/4"	3/4"	48	67,5	10/ 90

Heavy female hose tail, brass

2-pieces, plain, hot-pressed, heavy version, flat sealing including NBR seal, extended spout with hightened end rib for better fit of the hose

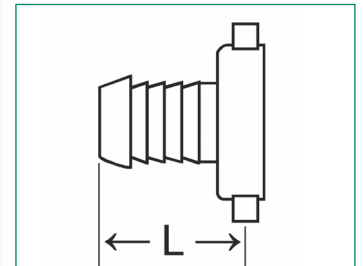
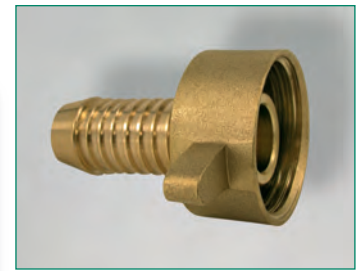

Item-No.:	Convec. spout:	Convec. thread:	Length: L	Packing unit:
34010 9	3/8"	1/2"	38	25/350
34011 9	1/2"	3/4"	43,5	25/250
34012 3	3/4"	1"	52	25/150
34013 0	1"	1 1/4"	62	10/100
34018 5	3/8"	3/4"	38,5	25/350
34019 2	5/8"	3/4"	39	25/500
34021 5	1/2"	1/2"	45	25/700
34022 2	3/4"	3/4"	50	25/200
34023 9	1"	1"	55,5	10/180
34028 4	1/2"	1"	43	25/350
34029 1	3/4"	1 1/4"	42	10/150

Heavy male hose tail, brass

1-piece, brass hot-pressed, heavy version, flat sealing including NBR seal, extended spout with hightened end rib for better fit of the hose

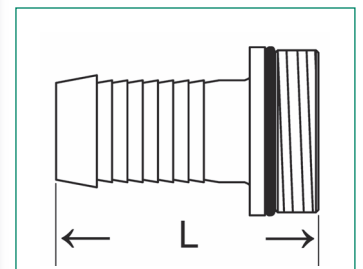

Item-No.:	Convec. spout:	Convec. thread:	Length: L	Packing unit:
34030 7	3/8"	1/2"	40	25/500
34031 4	1/2"	3/4"	45	25/500
34032 1	3/4"	1"	48,5	25/300
34033 8	1"	1 1/4"	57	10/150
34039 0	5/8"	3/4"	-	25/500
34041 3	1/2"	1/2"	-	25/700
34042 0	3/4"	3/4"	51	25/200
34043 7	1"	1"	57	10/150
34048 2	1/2"	1"	45	25/350
34049 9	3/4"	1 1/4"	-	10/350

3/3 Hose tail, brass

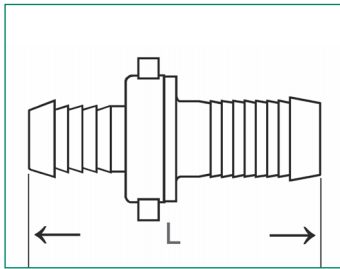
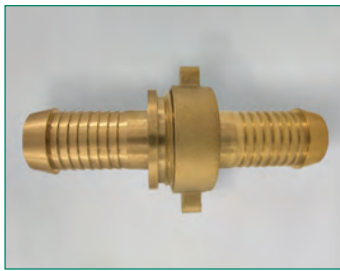

3-pieces, brass hot-pressed, heavy version, flat sealing including NBR seal, extended spouts with heightened end rib for better fit of the hose

Item-No.:	Connec. spout:	Connec. thread:	Length: L	Packing unit:
34050 5	3/8"	1/2"	-	25/200
34051 2	1/2"	3/4"	-	25/200
34052 9	3/4"	1"	98	25/150
34053 6	1"	1 1/4"	-	10/ 10
34058 1	5/8"	3/4"	-	20/ 20

Female hose tail, model „SWISS“, brass

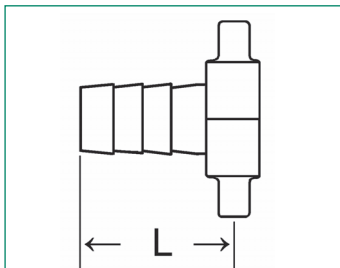

2-pieces, conduit fitting with hexagon nut cam, plain brass, hot-pressed, heavy version, flat sealing, extended hose with heightened end rib for better fit of the hose

Item-No.:	Connection: (spout x F thread)	Length: L	Packing unit:	Replacement seal:
34702 3	13 mm (1/2") x 3/4"	42,5	25/250	34717 7
34705 4	16 mm (5/8") x 1/2"	39	25/300	34716 0
34706 1	16 mm (5/8") x 3/4"	37	25/200	34717 7
34711 5	13 mm (1/2") x 1/2"	43	25/300	34716 0
34712 2	19 mm (3/4") x 3/4"	39,5	25/250	34717 7
34707 8	16 mm (5/8") x 1"	45	25/ 150	-
34713 9	19 mm (3/4") x 1"	45	25/ 150	-

Male hose tail, model „SWISS“, brass

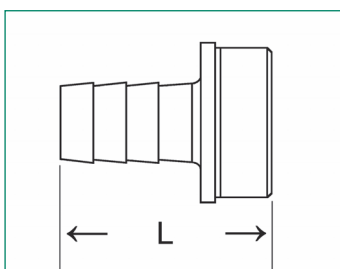
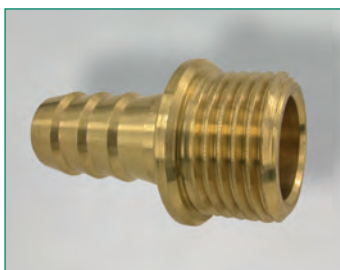

Plain brass

Item-No.:	Connection: (spout x male thread)	Length: L	Packing unit:
34722 1	13 mm (1/2") x 3/4"	41	25/300
34728 3	16 mm (5/8") x 1/2"	41	25/350
34729 0	16 mm (5/8") x 3/4"	46	25/300
34731 3	13 mm (1/2") x 1/2"	44	25/350
34732 0	19 mm (3/4") x 3/4"	45	25/250
34727 6	16 mm (5/8") x 1"	45	25/200
34723 87	19 mm (3/4") x 1"	45	25/200

Hose clamps 9 mm (W1)

Made of galvanized steel to DIN 3017, bandwidth 9 mm, wrench size 7 mm

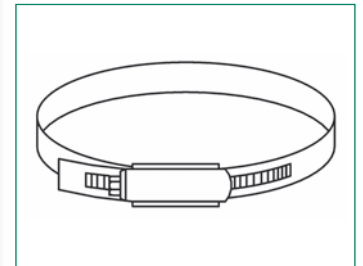

Item-No.:	Clamping range:	Packing unit:
34210 3	8 - 12 mm	100/ 1000
34216 5	8 - 16 mm	100/2000
34200 4	10 - 16 mm	100/ 1000
34201 1	12 - 22 mm	100/ 600
34202 8	16 - 27 mm	100/ 600
34203 5	20 - 32 mm	100/ 600
34204 2	25 - 40 mm	100/ 600
34205 9	35 - 50 mm	100/ 400
34206 6	40 - 60 mm	50/ 400
34211 0	50 - 70 mm	50/ 400
34207 3	60 - 80 mm	50/ 400
34239 4	60 - 170 mm	-/-
34208 0	70 - 90 mm	50/ 400
34209 7	80 - 100 mm	50/ 400
27080 2	80 - 130 mm	20/ 300
34212 7	90 - 110 mm	20/ 300
34213 4	100 - 120 mm	20/ 300
34215 8	110 - 130 mm	20/ 300
34218 9	120 - 140 mm	20/ 360
34219 6	130 - 150 mm	10/ 300
34214 1	140 - 160 mm	20/ 300
27081 9	150 - 170 mm	20/ 200
34217 2	160 - 180 mm	10/ 300
34220 2	190 - 210 mm	10/ 100

Hose clamps 9 mm (W1) with blue wing screw

Made of galvanized steel to DIN 3017, bandwidth 9 mm

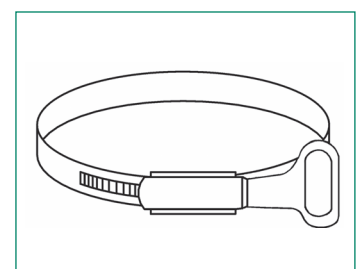

Item-No.:	Clamping range:	Packing unit:
34200-Knebel	10 - 16 mm	10/100
34202-Knebel	16 - 27 mm	10/100

Hose clamps 12 mm (W1)

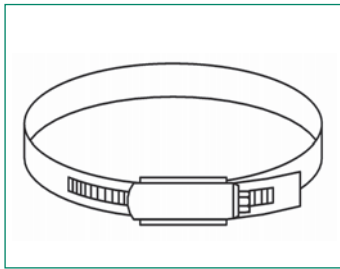

Made of galvanized steel, in accordance with DIN 3017, bandwidth 12 mm

Item-No.:	Clamping range:	Packing unit:
34221 9	12 - 22 mm	100/600
34222 6	16 - 27 mm	100/600
34223 3	20 - 32 mm	100/600
34224 0	25 - 40 mm	100/400
34225 7	35 - 50 mm	100/400
34226 4	40 - 60 mm	50/400
34227 1	50 - 70 mm	50/400
34228 8	60 - 80 mm	50/200
34229 5	70 - 90 mm	25/200
34230 1	80 - 100 mm	25/200
34237 0	90 - 110 mm	-/-
34231 8	100 - 120 mm	20/200
34235 6	140 - 160 mm	10/200
34236 3	160 - 180 mm	10/100

Stainless steel hose clamps 9 mm (W2)

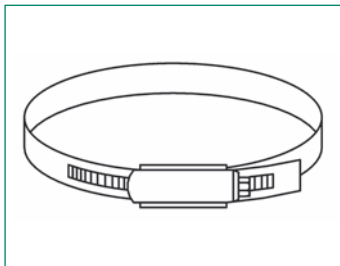

Band and housing made of stainless steel or equivalent corrosion-resistant steel in accordance with DIN 3017, zinc plated steel screw, bandwidth 9 mm

Item-No.:	Clamping range:	Packing unit:
34240 0	8 - 12 mm	100/1000
34241 7	10 - 16 mm	100/1000
34242 4	12 - 22 mm	100/600
34243 1	16 - 27 mm	100/600
34244 8	20 - 32 mm	100/600
34245 5	25 - 40 mm	100/600
34246 2	35 - 50 mm	100/400
34247 9	40 - 60 mm	50/400
34248 6	50 - 70 mm	50/400
34249 3	60 - 80 mm	50/400
34259 2	60 - 215 mm	-/-
34250 9	70 - 90 mm	50/400
34251 6	80 - 100 mm	50/400
34252 3	100 - 120 mm	20/300

Stainless steel hose clamps 12 mm (W2)

Band and housing made of stainless steel or equivalent corrosion-resistant steel in accordance with DIN 3017, zinc plated steel screw, bandwidth 12 mm

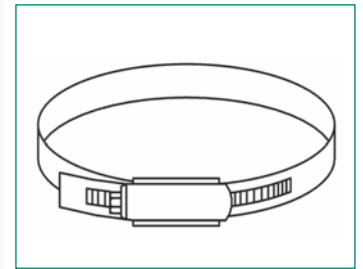

Item-No.:	Clamping range:	Packing unit:
34263 9	16 - 27 mm	100/600
34264 6	20 - 32 mm	100/600
34265 3	25 - 40 mm	100/400
34275 2	30 - 45 mm	-/-
34266 0	35 - 50 mm	100/400
34267 7	40 - 60 mm	50/400
34268 4	50 - 70 mm	50/400
34269 1	60 - 80 mm	50/200
34270 7	70 - 90 mm	25/200
34271 4	80 - 100 mm	25/200
34276 9	90 - 110 mm	10/ 300
34272 1	100 - 120 mm	10/ 300
34273 8	120 - 140 mm	-/-
34274 5	140 - 160 mm	-/-

Stainless steel hose clamps 9 mm (W4)

Band, housing and screw made of stainless steel or equivalent corrosion-resistant steel in accordance with DIN 3017, bandwidth 9 mm

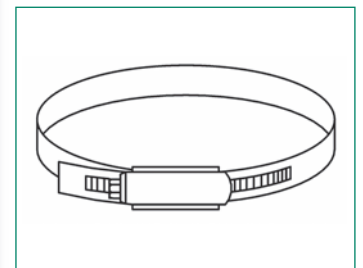

Item-No.:	Clamping range:	Packing unit:
35210 2	8 - 12 mm	100/1000
35216 4	8 - 16 mm	100/2000
35200 3	10 - 16 mm	100/1000
35201 0	12 - 22 mm	100/ 600
35202 7	16 - 27 mm	100/ 600
35203 4	20 - 32 mm	100/ 600
35204 1	25 - 40 mm	100/ 600
35213 3	30 - 45 mm	-/-
35205 8	35 - 50 mm	100/ 800
35206 5	40 - 60 mm	50/ 400
35211 9	50 - 70 mm	50/ 400
35207 2	60 - 80 mm	50/ 400
35208 9	70 - 90 mm	50/ 400
35209 6	80 - 100 mm	50/ 400
35212 6	90 - 110 mm	20/ 300

Stainless steel hose clamps 12 mm (W4)

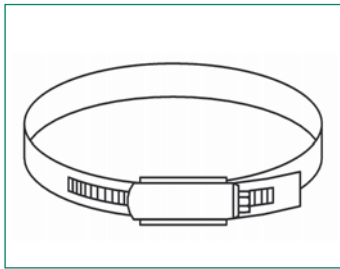

Band, housing and screw made of stainless steel or equivalent corrosion-resistant steel in accordance with DIN 3017, bandwidth 12 mm

Item-No.:	Clamping range:	Packing unit:
34281 3	12 - 22 mm	100/600
34282 0	16 - 25 mm	100/600
34283 7	20 - 32 mm	100/600
34284 4	25 - 40 mm	100/400
34285 1	35 - 50 mm	100/400
34286 8	40 - 60 mm	50/400
34288 2	70 - 90 mm	25/200
34289 9	80 - 100 mm	25/200
27310 0	60 - 80 mm	50/200
27312 4	100 - 120 mm	20/200
27311 7	110 - 130 mm	10/200
27318 6	160 - 180 mm	10/100

Stainless steel hose clamps 9 mm (W5)

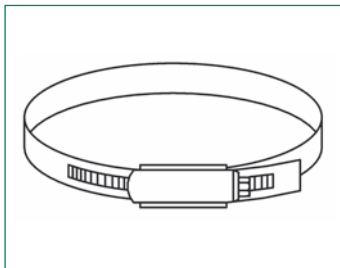

Band, housing and screw made of stainless steel or equivalent corrosion-resistant steel in accordance with DIN 3017, bandwidth 9 mm

Item-No.:	Clamping range:	Packing unit:
27200 4	8 - 12 mm	100/1000
27201 1	8 - 16 mm	100/1000
27202 8	10 - 16 mm	100/1000
27203 5	12 - 22 mm	100/600
27204 2	16 - 27 mm	100/600
27205 9	20 - 32 mm	100/600
27206 6	25 - 40 mm	100/600
27207 3	35 - 50 mm	100/400
27208 0	40 - 60 mm	50/400
27209 7	50 - 70 mm	50/400
27210 3	60 - 80 mm	50/400
27211 0	70 - 90 mm	50/400
27212 7	80 - 100 mm	50/400
27213 4	80 - 130 mm	25/200
27214 1	90 - 110 mm	20/300
27215 8	100 - 120 mm	20/300
27216 5	110 - 130 mm	20/300
27217 2	120 - 140 mm	20/360
27218 9	130 - 150 mm	20/300
27219 6	140 - 160 mm	10/300
27220 2	150 - 170 mm	10/300
27221 9	160 - 180 mm	10/300
27222 6	190 - 210 mm	10/

Stainless steel hose clamps 12 mm (W5)

Band, housing and screw made of stainless steel or equivalent corrosion-resistant steel in accordance with DIN 3017, bandwidth 12 mm

Item-No.:	Clamping range:	Packing unit:
27230 1	12 - 22 mm	100/600
27231 8	16 - 27 mm	100/600
27232 6	20 - 32 mm	100/600
27233 2	25 - 40 mm	100/400
27234 9	35 - 50 mm	100/400
27235 6	40 - 60 mm	50/400
27236 3	50 - 70 mm	50/400
27237 0	60 - 80 mm	50/200
27238 7	70 - 90 mm	25/200
27239 4	80 - 100 mm	25/200
27243 1	90 - 110 mm	20/200
27240 0	100 - 120 mm	20/200
27241 7	140 - 160 mm	10/200
27244 8	150 - 170 mm	-/-
27242 4	160 - 180 mm	10/300
27245 5	180 - 200 mm	-/-
27246 2	230 - 250 mm	-/-

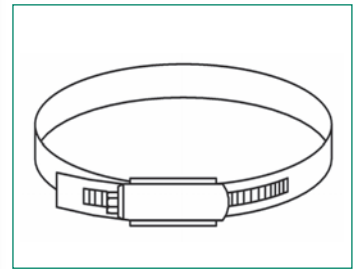

Heavy duty clamps (W4)

This special clamp is made entirely of stainless steel and is used where there are vibrations and large temperature fluctuations, which can cause the hose assemblies to expand and contract. The clamp maintains a constant pressure around the hose and prevents leaks.

Item-No.:	Clamping range:	Band width:	Wrench size:	Pack. unit:
S-3828-067	45 - 67 mm	15,8 mm	M10	-/150
S-3828-079	57 - 79 mm	15,8 mm	M10	-/150
S-3828-092	70 - 92 mm	15,8 mm	M10	-/150
S-3828-105	83 - 105 mm	15,8 mm	M10	-/100
S-3828-118	95 - 118 mm	15,8 mm	M10	-/100

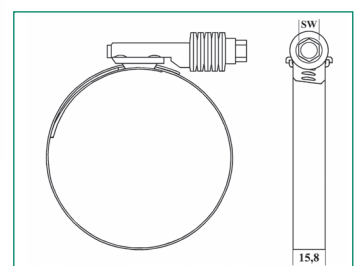

Double-wire hose clamps (W1)

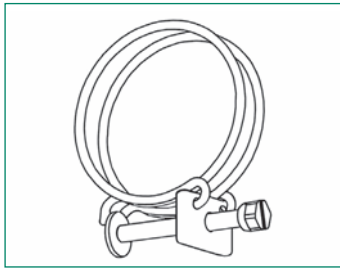

Ideal for the use with spiral hoses, made of galvanized steel, width about 8 mm

Item-No.:	Clamping range:	Packing unit:
27020 8	16 - 19 mm	50/1000
27021 5	18 - 21 mm	50/1000
27022 2	20 - 23 mm	50/1000
27023 9	22 - 25 mm	50/1000
27024 6	24 - 28 mm	50/ 500
27025 3	28 - 32 mm	50/ 400
27026 0	32 - 36 mm	50/ 400
27027 7	36 - 41 mm	50/ 400
27028 4	41 - 46 mm	50/ 400
27029 1	43 - 48 mm	50/ 400
27030 7	47 - 53 mm	50/ 200
27031 4	51 - 58 mm	50/ 200
27032 1	57 - 63 mm	50/ 200

Mini-hose clamps 9 mm, galvanized steel (W1)

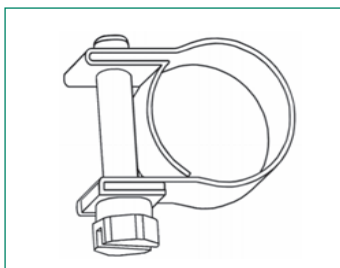

Made of galvanized steel, bandwidth 9 mm

Item-No.:	Clamping range:	Packing unit:
27000 0	6 - 8 mm	100/3000
27001 7	7 - 9 mm	100/3000
27002 4	8 - 10 mm	100/1000
27004 8	10 - 12 mm	100/1000
27005 5	11 - 13 mm	100/1000
27006 2	12 - 14 mm	100/1000

Heavy duty clamps (W1)

Band, housing and screw made of galvanized steel

Item-No.:	Clamping range:	Bandwidth:	Packing unit:
35221 8	17 - 19 mm	18 mm	50/200
35222 5	19 - 21 mm	18 mm	50/200
35223 2	21 - 23 mm	18 mm	50/200
35224 9	23 - 25 mm	18 mm	50/200
35225 6	26 - 28 mm	18 mm	50/200
35226 3	29 - 31 mm	20 mm	50/200
35227 0	32 - 35 mm	20 mm	50/200
35228 7	36 - 39 mm	20 mm	50/100
35229 4	40 - 43 mm	20 mm	50/100
35230 0	44 - 47 mm	22 mm	50/100
35231 7	48 - 51 mm	22 mm	50/100
35232 4	52 - 55 mm	22 mm	25/100
35233 1	56 - 59 mm	22 mm	25/100
35234 8	60 - 63 mm	22 mm	25/100
35235 5	64 - 67 mm	22 mm	25/100
35236 2	68 - 73 mm	24 mm	25/100
35237 9	74 - 79 mm	24 mm	25/100
35238 6	80 - 85 mm	24 mm	25/ 50
35239 3	86 - 91 mm	24 mm	25/ 50
35240 9	90 - 95 mm	24 mm	25/ 50
35241 9	92 - 97 mm	24 mm	25/ 50
35242 3	98 - 103 mm	24 mm	25/ 50
35243 0	104 - 112 mm	24 mm	25/ 50
35244 7	113 - 121 mm	24 mm	25/ 50
35246 1	140 - 148 mm	26 mm	-/-
35249 2	162 - 174 mm	26 mm	10/ 40
35248 5	214 - 226 mm	26 mm	-/-

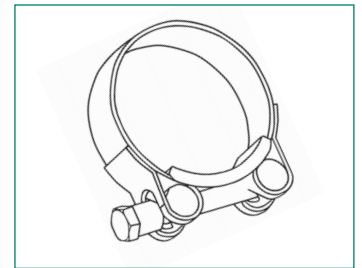

Heavy duty clamps (W2)

Band and housing made of stainless steel or equivalent corrosion-resistant steel in accordance with DIN 3017, zinc plated steel screw

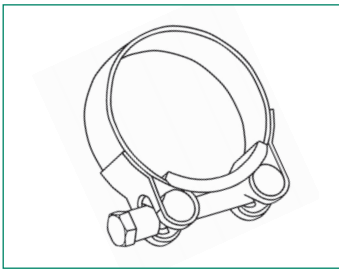

Item-No.:	Clamping range:	Bandwidth:	Packing unit:
35261 4	17 - 19 mm	18 mm	50/200
35262 1	19 - 21 mm	18 mm	50/200
35263 8	21 - 23 mm	18 mm	50/200
35264 5	23 - 25 mm	18 mm	50/200
35265 2	26 - 28 mm	18 mm	50/200
35267 6	29 - 31 mm	20 mm	50/200
35268 3	32 - 35 mm	20 mm	50/200
35269 0	36 - 39 mm	20 mm	50/100
35271 3	40 - 43 mm	20 mm	50/100
35272 0	44 - 47 mm	22 mm	50/100
35273 7	48 - 51 mm	22 mm	50/100
35274 4	52 - 55 mm	22 mm	25/100
35275 1	56 - 59 mm	22 mm	25/100
35276 8	60 - 63 mm	22 mm	25/100
35277 5	64 - 67 mm	22 mm	25/100
35278 2	68 - 73 mm	24 mm	25/100
35279 9	74 - 79 mm	24 mm	25/100
35280 5	80 - 85 mm	24 mm	25/ 50
35281 2	86 - 91 mm	24 mm	25/ 50
35282 9	92 - 97 mm	24 mm	25/ 50
35283 6	98 - 103 mm	24 mm	25/ 50
35284 3	104 - 112 mm	24 mm	25/ 50
35285 0	113 - 121 mm	24 mm	25/ 50
35286 7	122 - 130 mm	24 mm	25/ 50
35287 4	131 - 140 mm	26 mm	25/ 50
35288 1	140 - 148 mm	26 mm	10/ 40
35289 8	149 - 162 mm	26 mm	25/ 50
35290 4	162 - 174 mm	26 mm	10/ 40
35291 1	174 - 187 mm	26 mm	25/ 50
35292 8	187 - 200 mm	26 mm	25/ 50
35293 5	227 - 239 mm	26 mm	-/-

Classes of materials for worm drive clamps or heavy duty clamps

Desig.:	Material:	Requirement:
W1	Coated steel	Low requirements on the corrosion resistance
W2	Housing and band stainless steel 1.4016; Screw coated steel	Low to medium requirements on the corrosion resistance
W4	Completely made of steel 1.4301 (V2A or comparable steel)	High requirements on the corrosion resistance
W5	Completely made of chromium-nickle-molybdenum steel 1.4571 (V4A oder 1.4401)	Resistant to sea water and difficult to magnetize; highest requirements on the corrosion resistance

Double heavy duty clamps (W1)

Band, housing and screw made of galvanized steel

Item-No.:	Clamping range:	Bandwidth:	Packing unit:
27357 5	100 - 110 mm	24 mm	-/20
27358 2	110 - 120 mm	24 mm	-/20
27363 6	160 - 170 mm	24 mm	-/20



Endless clamp with foldable housing

2-parts, band stainless steel 1.4104, housing and screw zinc plated steel, bandwidth 9 mm

Item-No.:	Clamping range:	Bandwidth:	Packing unit:
SE-3075	50-165 mm	9 mm	-/-



Perforated stainless steel band

Item-No.:	Length (m):	Bandwidth:	Packing unit:
27060 4	3	8 mm	1/bag
27061 1	5	8 mm	1/bag
27062 8	25	8 mm	1/bag
27063 5	3	14 mm	1/bag
27064 2	5	14 mm	1/bag
27065 9	25	14 mm	1/bag

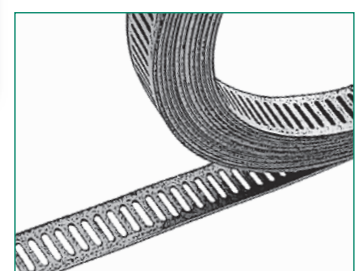
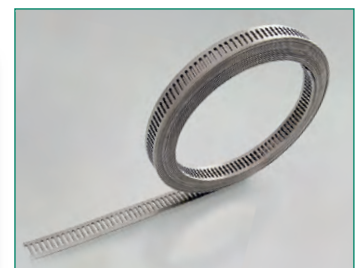

Endless band (W2)

Housing/screws in set (W2)



Housing/screws (zinc plated) for endless band

Item-No.:	Bandwidth:	Packing unit:
27066 6	8 mm	8/bag
27067 3	8 mm	6/bag
27068 0	14 mm	8/bag
27069 7	14 mm	6/bag



2-ear-clamps (W1)



Made of zinc plated steel

Item-No.:	Clamping range:	Packing unit:
27085 7	5 - 7 mm	100/2000
27086 4	7 - 9 mm	100/2000
27087 1	9 - 11 mm	100/2000
27082 6	11 - 13 mm	100/2000
27083 3	13 - 15 mm	100/2000
27088 8	14 - 17 mm	100/2000
27084 0	15 - 18 mm	100/2000
27089 5	18 - 21 mm	100/2000
27090 1	20 - 23 mm	100/2000

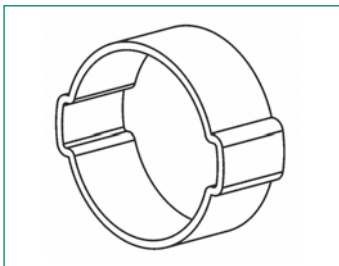

Pipe clamp



2 bolts, galvanized steel, without soundproofing rubber

Item-No.:	Connection nominal diameter:	Packing unit:
S-080	DN 100 mm	1/50

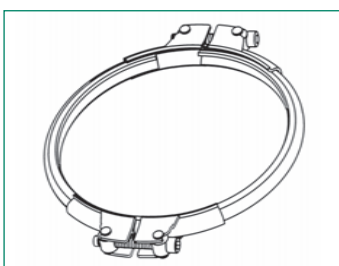

Assembly of endless clamp bands

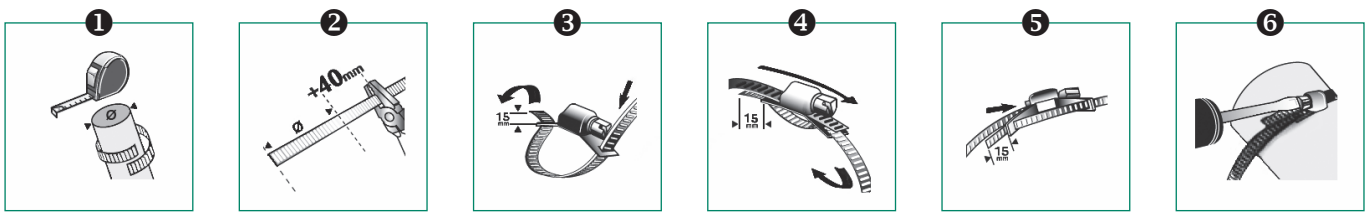

Assembly of 2-ear-clamps

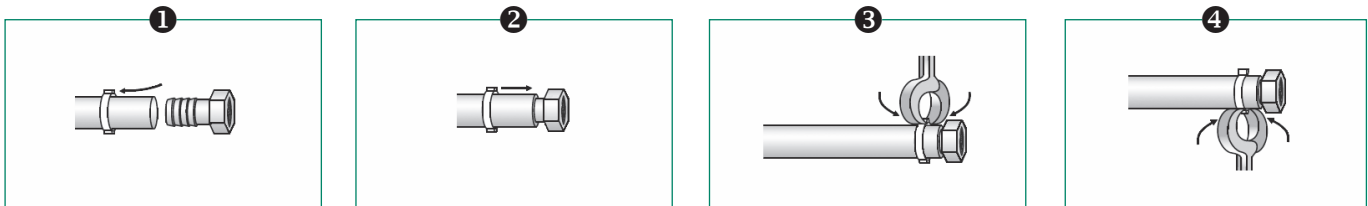

Pipe clamps made of Zamak or alternatively with brass coating, 2 galvanized steel clamping screws with cross recess and a female thread M7

Zamak pipe clamp

Item-No.:	Item-No.:	Dimension:	Packing unit:
Zamak	Brass		
27279 0	27279-MS	8 mm	50/2000
27280 6	27280-MS	10 mm	200/1400
27281 3	27281-MS	12 mm	200/1400
27282 0	27282-MS	15 mm	200/1200
27283-16	-	16 mm	50/1000
27283-17	-	17 mm	50/1000
27283 7	27283-MS	18 mm	150/ 750
27284-19	-	19 mm	70/ 840
27284-20	-	20 mm	60/ 720
27284-21	-	21 mm	60/ 720
27284 4	27284-MS	22 mm	150/ 600
27285-24	-	24 mm	50/ 500
27285-25	-	25 mm	50/ 500
27285 1	27285-MS	27 mm	90/ 540
27286 8	27286-MS	28 mm	86/ 425
27287 5	27287-MS	32 mm	65/ 325
27288 2	27288-MS	34 mm	60/ 300
27289 9	27289-MS	40 mm	55/ 275
27290 5	27290-MS	42 mm	50/ 250
27290-43	-	43 mm	50/ 250
27291-48	-	48 mm	40/ 200
27291 2	27291-MS	50 mm	50/ 200
27270-60	-	60 mm	25/ 125
27270 7	-	63 mm	25/ 125
27271-76	-	76 mm	25/ 100

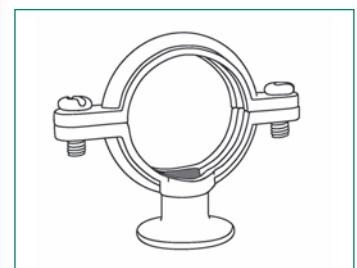

Clamp ring, brass

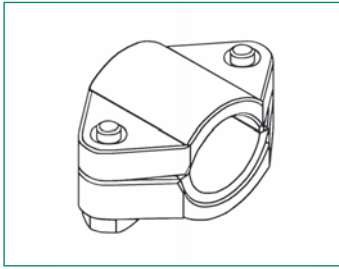

2-parts with galvanized hexagon head bolts and nuts, ideal for tightening pump-spiral hoses

Item-No.:	Clamping range:	Connection:	Packing unit:
34402 2	25 - 27 mm	3/4"	10/200
34403 9	31 - 34 mm	1"	10/200
34404 6	38 - 41 mm	1 1/4"	10/150

Suntos® quality hose



Yellow multi-layer water hose, UV-resistant, knitted anti-kink insert, temperature range: - 10° C to + 50° C, cadmium and barium free

Item-No.:	m/roll:	Connection:	Inner diameter: mm	Pressure resistance: bar	Packing unit:
37201 8	20	1/2"	12,5	36	99
37301 5	30	1/2"	12,5	36	66
37501 9	50	1/2"	12,5	36	42
37252 0	25	3/4"	19	27	30
37502 6	50	3/4"	19	27	16
37112 7	100	3/4"	19	27	4
37253 7	25	1"	25	24	10
37503 3	50	1"	25	24	6
37504 0	50	1 1/4"	32	18	a. A.
37505 7	50	1 1/2"	38	12	a. A.
37506 4	50	2"	50	12	a. A.

Aluminum bracket

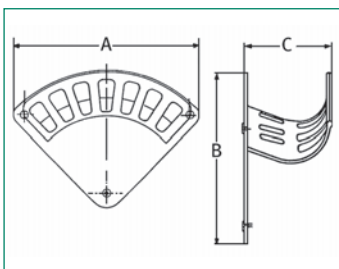

Wall bracket suitable for hose, cable and rope

Item-No.:	Size: A (width) B (height) C (depth)	Packing unit:
38111 9	S = 190 x 140 x 70 mm	-/-
38112 6	M = 260 x 190 x 105 mm	-/-
38113 3	L = 335 x 245 x 135 mm	-/-
38114 0	XL = 415 x 300 x 190 mm	-/-

Compression fittings, brass, for PE-pipes

Compression fittings for plastic pipes (HDPE and LDPE) in sizes from 1/2" x 20 mm to 3" x 90 mm. Suitable for piping systems underground or above ground level for fixed or mobile installation. For conveying potable water, waste water and other liquid media.

Material: brass (MS 58)

maximum operating pressure: 16 bar
 operating temperature: -20°C to +120°C
 application range: Gas approved, tested according to DIN DVGW V 114 W



Consisting of housing, for example female thread, O-ring, pressure ring, clamping ring and screws (nut). For the medium gas a gas sleeve or a support tube must be used in addition.

Straight form, with female thread and union nut

Item-No.:	Female thread-size	PE-pipe-size	PE-pipe- outside Ø	Packing unit:
34501 2	G 1/2"	1/2"	20 mm	20/320
34502 9	G 3/4"	3/4"	25 mm	15/165
34503 6	G 1"	1"	32 mm	12/120
34504 3	G 1 1/4"	1 1/4"	40 mm	6/ 60
34505 0	G 1 1/2"	1 1/2"	50 mm	4/ 72
34506 7	G 2"	2"	63 mm	2/ 38



Straight form, with male thread and union nut

Item-No.:	Male thread-size	PE-pipe-size	PE-pipe- outside Ø	Packing unit:
34511 1	G 1/2"	1/2"	20 mm	20/320
34512 8	G 3/4"	3/4"	25 mm	15/240
34513 5	G 1"	1"	32 mm	12/120
34514 2	G 1 1/4"	1 1/4"	40 mm	6/ 60
34515 9	G 1 1/2"	1 1/2"	50 mm	4/ 72
34516 6	G 2"	2"	63 mm	2/ 38



Elbow, with two union nuts

Item-No.:	PE-pipe-size	PE-pipe- outside Ø	Packing unit:
34571 5	1/2"	20 mm	12/216
34572 2	3/4"	25 mm	10/100
34573 9	1"	32 mm	6/ 78
34574 6	1 1/4"	40 mm	4/ 48
34575 3	1 1/2"	50 mm	2/ 36
34576 0	2"	63 mm	2/ 14



Elbow, with female thread and union nut



Item-No.:	Female thread-size	PE-pipe-size	PE-pipe- outside Ø	Packing unit:
34521 0	G 1/2"	1/2"	20 mm	15/240
34522 7	G 3/4"	3/4"	25 mm	12/ 192
34523 4	G 1"	1"	32 mm	8/ 104
34524 1	G 1 1/4"	1 1/4"	40 mm	6/ 72
34525 8	G 1 1/2"	1 1/2"	50 mm	4/ 48

Elbow, with male thread and union nut



Item-No.:	Male thread-size	PE-pipe-size	PE-pipe- outside Ø	Packing unit:
34531 9	G 1/2"	1/2"	20 mm	15/240
34532 6	G 3/4"	3/4"	25 mm	12/ 120
34533 3	G 1"	1"	32 mm	8/ 80
34534 0	G 1 1/4"	1 1/4"	40 mm	6/ 72
34535 7	G 1 1/2"	1 1/2"	50 mm	4/ 48
34536 4	2"	2"	63 mm	2/ 38

Elbow, with female thread, union nut and wall fixation



Item-No.:	Female thread-size	PE-pipe-size	PE-pipe- outside Ø	Packing unit:
34541 8	G 1/2"	1/2"	20 mm	15/150
34542 5	G 3/4"	3/4"	25 mm	12/156
34543 2	G 1"	1"	32 mm	8/ 64

T-piece, with three union nuts



Item-No.:	PE-pipe-size	PE-pipe- outside Ø	Packing unit:
34566 1	1/2"	20 mm	6/144
34567 8	3/4"	25 mm	6/108
34568 5	1"	32 mm	4/ 52
34569 2	1 1/4"	40 mm	4/ 36
34570 8	1 1/2"	50 mm	2/ 28
34560 9	2"	63 mm	1/ 8

T-piece, with female thread and two union nuts

Item-No.:	Female thread-size	PE-pipe-size	PE-pipe- outside Ø	Packing unit:
34551 7	G 1/2"	1/2"	20 mm	8/192
34552 4	G 3/4"	3/4"	25 mm	6/ 96
34553 1	G 1"	1"	32 mm	4/ 72
34554 8	G 1 1/4"	1 1/4"	40 mm	4/ 36
34555 5	G 1 1/2"	1 1/2"	50 mm	2/ 26

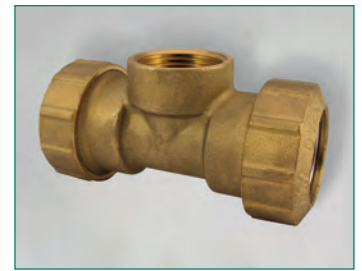

Straight short form, with two union nuts

Item-No.:	PE-pipe-size	PE-pipe- outside Ø	Packing unit:
34581 4	1/2"	20 mm	12/192
34582 1	3/4"	25 mm	10/160
34583 8	1"	32 mm	8/104
34584 5	1 1/4"	40 mm	4/ 80
34585 2	1 1/2"	50 mm	2/ 48
34580 7	2"	63 mm	2/ 16



Straight long form, with two union nuts

Item-No.:	PE-pipe-size	PE-pipe- outside Ø	Packing unit:
34586 9	1"	32 mm	6/72
34587 6	1 1/4"	40 mm	4/36
34588 3	1 1/2"	50 mm	2/36
34589 0	2"	63 mm	2/14



Sealing set for PE pipe compression fittings

Item-No.:	PE-pipe-size	PE-pipe- outside Ø	Packing unit:
34591 3	1/2"	20 mm	-/100
34592 0	3/4"	25 mm	-/ 75
34593 7	1"	32 mm	-/ 50
34594 4	1 1/4"	40 mm	-/ 30



Supporting ferrule



Stainless steel, necessary for the use with the medium gas, only for PE pipe compression fittings made of brass

Item-No.:	PE-pipe-size	Packing unit:
34500 5	1/2"	-/100
34510 4	3/4"	-/ 75
34520 3	1"	-/ 50
34530 2	1 1/4"	-/ 30

Compression fittings, polypropylene, for PE-pipes

Material: PP

maximum operating pressure: 10 bar

operating temperature: 0°C bis + 30°C

application range: Irrigation and spray irrigation, not suitable for gas or compressed air.

Consisting of housing, for example female thread, O-ring, pressure ring, clamping ring and union nut.

Straight form, with two union nuts



Item-No.:	Female thread-size	PE-pipe- outside Ø	Packing unit:
35581 3	1/2"	20 mm	50/300
35582 0	3/4"	25 mm	50/200
35583 7	1"	32 mm	50/ 150
35584 4	1 1/4"	40 mm	-/ 90
35585 1	1 1/2"	50 mm	-/ 50
35586 8	2"	63 mm	-/ 30

Straight form, with female thread and union nut



Item-No.:	Female thread-size	PE-pipe-size	PE-pipe- outside Ø	Packing unit:
35501 1	1/2"	1/2"	20 mm	50/350
35502 8	3/4"	3/4"	25 mm	50/350
35503 5	1"	1"	32 mm	50/200
35504 2	1 1/4"	1 1/4"	40 mm	-/ 125
35505 9	1 1/2"	1 1/2"	50 mm	-/ 75
35506 6	2"	2"	63 mm	-/ 65

Straight form, with male thread and union nut

Item-No.:	Male thread-size	PE-pipe-size	PE-pipe- outside Ø	Packing unit:
35511 0	1/2"	1/2"	20 mm	50/550
35512 7	3/4"	3/4"	25 mm	50/350
35513 4	1"	1"	32 mm	50/200
35514 1	1 1/4"	1 1/4"	40 mm	-/ 130
35515 8	1 1/2"	1 1/2"	50 mm	-/ 80
35516 5	2"	2"	63 mm	-/ 45



Elbow, with two union nuts

Item-No.:	PE-pipe-size	PE-pipe- outside Ø	Packing unit:
35571 7	1/2"	20 mm	50/250
35572 1	3/4"	25 mm	50/200
35573 8	1"	32 mm	-/ 50
35574 5	1 1/4"	40 mm	-/ 70
35575 2	1 1/2"	50 mm	-/ 40
35576 9	2"	63 mm	-/ 23



Elbow, with female thread and union nut

Item-No.:	Female thread-size	PE-pipe-size	PE-pipe- outside Ø	Packing unit:
35521 9	1/2"	1/2"	20 mm	20/460
35522 6	3/4"	3/4"	25 mm	20/300
35523 3	1"	1"	32 mm	50/ 150
35524 0	1 1/4"	1 1/4"	40 mm	5/ 90
35525 7	1 1/2"	1 1/2"	50 mm	-/ 55
35526 4	2"	2"	63 mm	-/ 30



Elbow, with male thread and union nut

Item-No.:	Male thread-size	PE-pipe-size	PE-pipe- outside Ø	Packing unit:
35531 8	1/2"	1/2"	20 mm	50/450
35532 5	3/4"	3/4"	25 mm	50/300
35533 2	1"	1"	32 mm	50/ 150
35534 9	1 1/4"	1 1/4"	40 mm	-/ 120
35535 6	1 1/2"	1 1/2"	50 mm	-/ 60
35536 3	2"	2"	63 mm	-/ 35



T-piece, with three union nuts



Item-No.:	PE-pipe-size	PE-pipe- outside Ø	Packing unit:
35566 0	1/2"	20 mm	50/150
35567 7	3/4"	25 mm	50/150
35568 4	1"	32 mm	-/ 80
35569 1	1 1/4"	40 mm	-/ 45
35559 2	1 1/2"	50 mm	-/ 25
35560 8	2"	63 mm	-/ 14

T-piece, with female thread and two union nuts



Item-No.:	Female thread-size	PE-pipe-size	PE-pipe- outside Ø	Packing unit:
35551 6	1/2"	1/2"	20 mm	20/240
35552 3	3/4"	3/4"	25 mm	10/ 150
35553 0	1"	1"	32 mm	50/ 100
35554 7	1 1/4"	1 1/4"	40 mm	-/ 60
35555 4	1 1/2"	1 1/2"	50 mm	-/ 33
35556 1	2"	2"	63 mm	-/ 20
35550 9	3/4"	1"	32 mm	-/ 100

T-piece, with male thread and two union nuts



Item-No.:	Male thread-size	PE-pipe-size	PE-pipe- outside Ø	Packing unit:
35541 7	1/2"	1/2"	20 mm	50/200
35542 4	3/4"	3/4"	25 mm	50/ 150
35543 1	1"	1"	32 mm	-/ 100
35544 8	1 1/4"	1 1/4"	40 mm	-/ 50
35545 5	1 1/2"	1 1/2"	50 mm	-/ 30
35546 2	2"	2"	63 mm	-/ 18

Brass quick couplings, suitable for normal plug-in couplings, max 16 bar with +20°C

Made of aluminium, solid version, plastic-coated, female threaded connection 3/4" with seal – adjustable to 6 operating modes.

With mounted brass express coupling.

- Jet types:
- ⇒ normal spray
 - ⇒ shower spray
 - ⇒ jet spray
 - ⇒ fog jet
 - ⇒ fan jet
 - ⇒ soft spray

Item-No.:	Connection:	Packing unit:
33093 3	3/4" female thread	1/48
without plug-in coupling		
33095 7	3/4" female thread	1/48

Made of aluminium, solid version, plastic-coated, female threaded connection 3/4" with seal, adjustable from spray to full beam.

With mounted brass express coupling.

Item-No.:	Connection:	Packing unit:
33092 6	3/4" female thread	1/48
without plug-in coupling		
33094 0	3/4" female thread	1/48

Replacement flat seal for 33093 + 33092

without illustration, material NBR

Item-No.:	Connection:	Packing unit:
33063 6	3/4"	2500

Suitable for brass plug-in-system

Item-No.:	Connection:	Length:	Packing unit:
plain	chrome-plated	L	
33091 9	33096 4	97	10/100

Garden hand shower

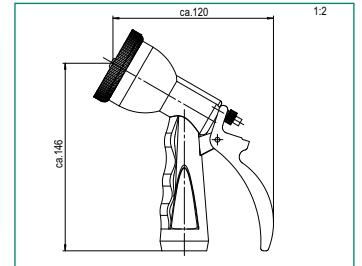

Garden spray pistol

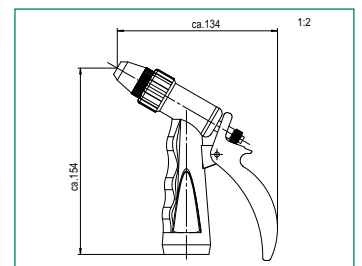

Spray nozzle

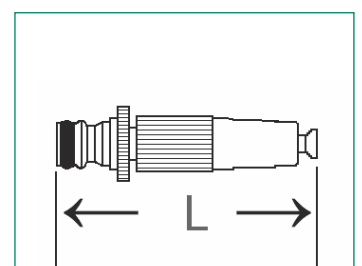

Hose connector without water stop



With three stainless steel balls

Item-No.:	Item-No.:	Connection:	Length:	Packing unit:
plain	chrome-plated		L	
33031 5	33036 0	1/2" (+5/8")	47	10/ 130
33032 2	33037 7	3/4"	52,5	10/ 90

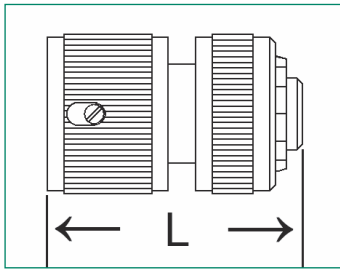

Hose connector with water stop



With three stainless steel balls

Item-No.:	Item-No.:	Connection:	Length:	Packing unit:
plain	chrome-plated		L	
33041 4	33046 9	1/2" (+5/8")	46	10/ 120
33042 1	33047 6	3/4"	52,5	10/ 90

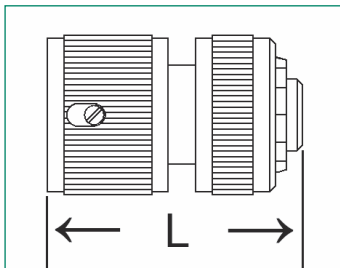

Tap connector, female thread



Item-No.:	Item-No.:	Connection:	Length:	Packing unit:
plain	chrome-plated		L	
33121 3	33126 8	1/2"	35,5	25/ 350
33122 0	33127 5	3/4"	35	20/ 250
33123 7	33128 2	1"	37	25/ 175

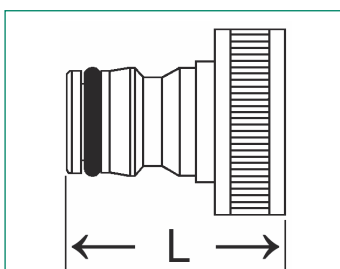

Tap connector, female thread

Item-No.:	Item-No.:	Connection:	Length:	Connection:	Pack. unit:
plain	chrome-plated		L	hose	
33034 6	33039 1	G 3/4"	43	16/19 mm (3/4")	10/140

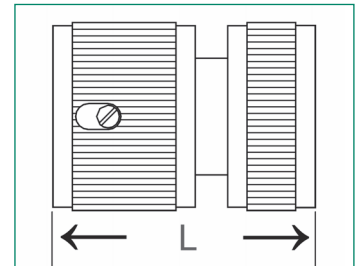

Accessory adapter, male thread

Item-No.:	Item-No.:	Connection:	Length:	Packing unit:
plain	chrome-plated		L	
33221 0	33226 5	1/2"	31	25/450
33222 7	33227 2	3/4"	31,5	25/350

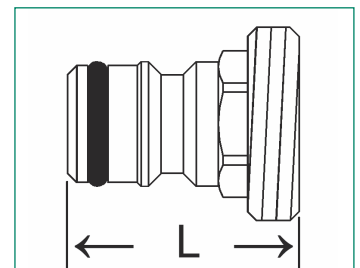

Hose connector with plug

Item-No.:	Item-No.:	Connection:	Length:	Packing unit:
plain	chrome-plated		L	
33021 6	33026 1	1/2"	49	10/160
33022 3	33027 8	3/4"	54	10/100

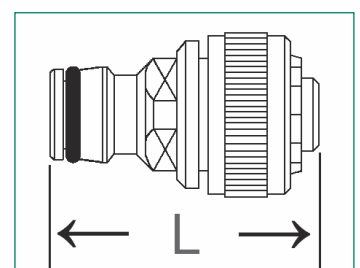
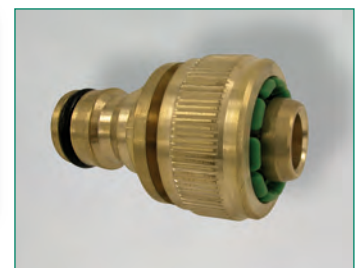

Hose repairer



With three stainless steel balls

Item-No.:	Item-No.:	Connection:	Length:	Packing unit:
plain	chrome-plated		L	
33321 7	33326 3	1/2" (+5/8")	42	10/150
33322 4	33327 9	3/4"	51,5	10/ 80

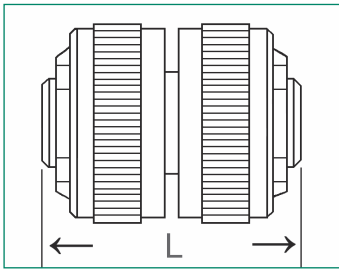

Double plug

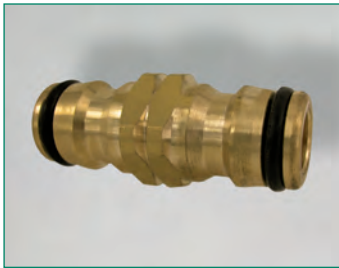

Item-No.:	Item-No.:	Connection:	Length:	Packing unit:
plain	chrome-plated		L	
33051 3	33056 8	-	49	25/300

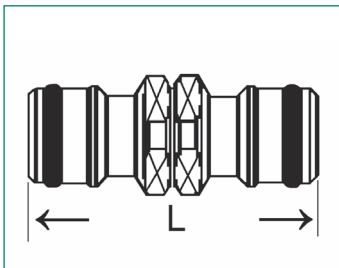

Angled tap connector with female thread



Item-No.:	Item-No.:	Conne.:	Length:		Packing unit:	Packing unit:
			L1	L2		
plain	chrome-plated				plain	chrome-plated
33062 9	33067 4	3/4"	31,5	45	10/140	10/150
Heavy version						
33062-schwer	33067-schwer	3/4"	36	51	10/110	

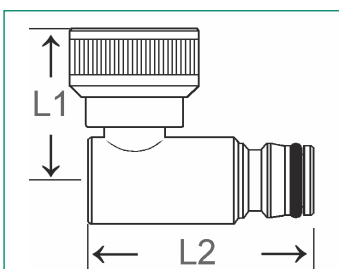

3-way coupling, brass connector system

All pages plug-in coupling

Item-No.:	Item-No.:	Length:		Packing unit:
plain	chrome-plated	L1	L2	
33052 0	33057 5	62	72	10/110

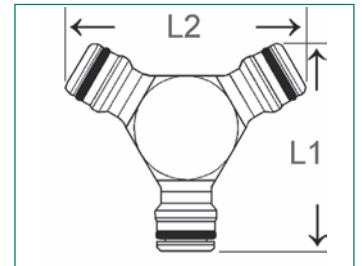

Twin tap connector for 2 operating watering accessoires, brass connector system

1 x female thread, 2 x couplings

Item-No.:	Item-No.:	Conne.:	Length:		Packing unit:
plain	chrome-plated		L1	L2	
53312 9	53317 4	3/4" f	90	99,5	2/40

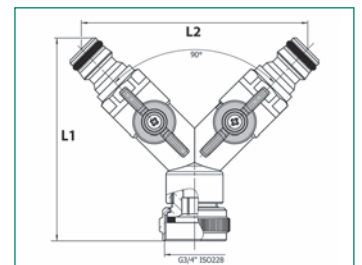

Twin tap connector for 2 operating watering accessoires, brass connector system

3 x couplings

Item-No.:	Item-No.:	Length:		Packing unit:
plain	chrome-plated	L1	L2	
53313 6	53318 1	104	99,5	2/40

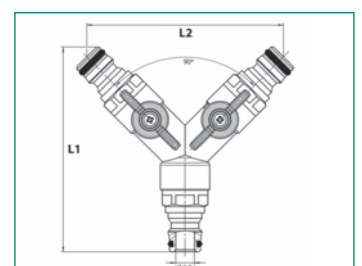
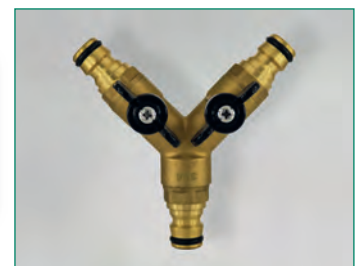

Spare Parts for brass plug system

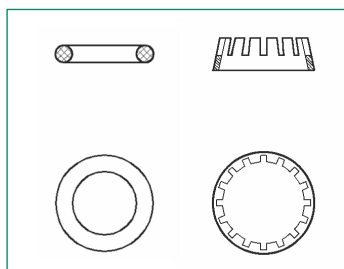

Item-No.:	Description:	Packing unit:
33911 0	NBR-Flat gasket for brass plug system with 1/2" female	500/10000
33912 7	NBR-Flat gasket for brass plug system with 3/4" female	500/ 7000
33913 4	NBR-Flat gasket for brass plug system with 1" female	250/ 4000
33065 0	Replacement O-ring (NBR)	-/-
33068 1	Replacement compression ring (PA) 1/2"	-/-
33069 8	Replacement compression ring (PA) 3/4"	-/-
33099 5	Replacement O-ring for 33091/96 (NBR)	-/-

Transition piece

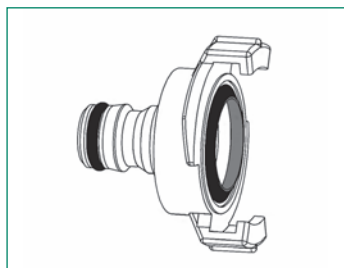

Plug-in coupling with quick coupling (1-piece), plain brass, universal size

Item-No.:	Item-No.:	Connection:	Length:	Packing unit:
plain	chrome-plated		L	
33904 2	-		55,5	10/180

Transition piece

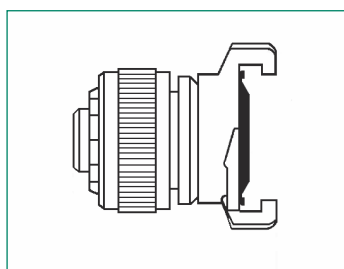

Hose connector with quick coupling (with water stop), plain brass

Item-No.:	Item-No.:	Connection:	Length:	Packing unit:
plain	chrome-plated		L	
33043 8	-	12/15 mm (1/2")		10/150
33044 5	-	16/19 mm (3/4")		10/120

Series MST

Express claw couplings of forged brass, internal cam distance 40 mm, PN 10, to match the current systems, NBR-seal, is suitable for drinking water, seals black: with KTW-A/W-270-approval, brass according to the German Drinking Water Ordinance, temperature range: app. – 30°C to + 100°C, bursting pressure: min. 30 bar

Coupling with tailpiece

Item-No.:	Conn.:	DN:	Length:	Packing unit:
KTW-A seal black			L	
33008 7	1/4"		44	10/300
33000 1	3/8"	10	49	10/200
33001 8	1/2"	15	47,5	10/180
33009 4	5/8"	15	52,5	10/160
33002 5	3/4"	20	51,5	10/160
33003 2	1"	25	58	10/120
33004 9	1 1/4"	32	65,5	10/100
33005 6	1 1/2"	40	73	10/ 60

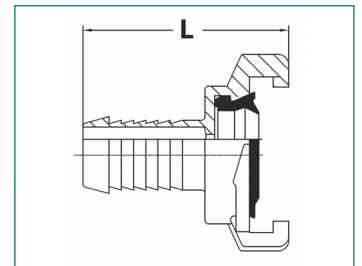

Coupling, female threaded

Item-No.:	Conn.:	DN:	Length:	Packing unit:
KTW-A seal black			L	
33108 4	1/4"		30,5	10/220
33100 8	3/8"	10	30,5	10/220
33101 5	1/2"	15	30,5	10/220
33102 2	3/4"	20	30,5	10/240
33103 9	1"	25	31,5	10/220
33104 6	1 1/4"	32	34,5	10/200
33105 3	1 1/2"	40	37	10/100
Special sizes				
33101-19 mm	1/2", female 19 mm long		42,5	10/220
33102-19 mm	3/4", female 19 mm long		42,5	10/160

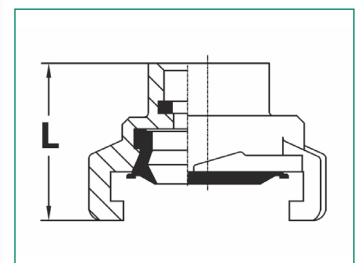

Coupling, male threaded

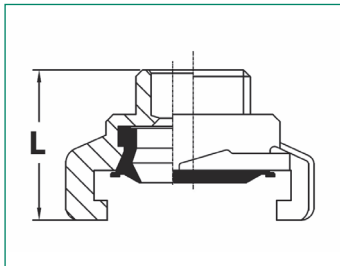

Item-No.:	Conn.:	DN:	Length:	Packing unit:
KTW-A seal black			L	
33208 1	1/4"		31	10/220
33200 5	3/8"	10	31	10/220
33201 2	1/2"	15	31	10/220
33202 9	3/4"	20	31	10/200
33203 6	1"	25	31	10/180
33204 3	1 1/4"	32	34,5	10/140
33205 0	1 1/2"	40	36	10/120

Blind cap

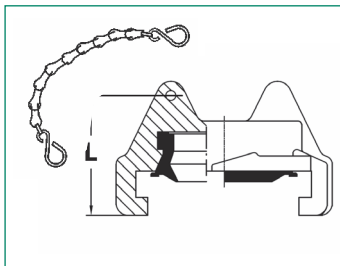

Fits all sizes, hole for attaching a chain (without chain)

Item-No.:	DN:	Conn. for borehole:	Length:	Packing unit:
KTW-A seal black			L	
33901 1	40	2,5	29,5	10/220
33901-Kette		chain for 33901	-	

Coupling with tailpiece, rotating

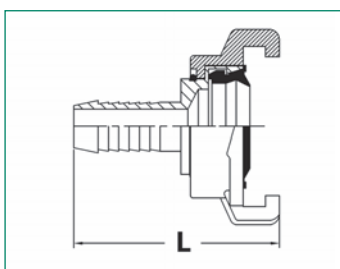

2-piece tube made of brass, spout 360° rotating, very light coupling

Item-No.:	Conn.:	DN:	Length:	Packing unit:
KTW-A seal black	spout		L	
33011 7	1/2"	15	54	10/140
33012 4	3/4"	20	57	10/120
33013 1	1"	25	60,5	10/100

Plastic express coupling with lock nut, tailpiece

For suction lines, absolutely tight and protected against loosening, secured by guard ring

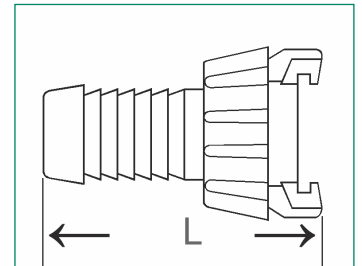

Item-No.:	Spout:	Length: L	Packing unit:
33412 2	3/4"	80	10/200
33413 9	1"	90	10/200

Express coupling with lock nut made of brass, male threaded

Suction and high pressure coupling with male thread (wrench size 24) for suction lines, absolutely tight and secured against loosening by protecting ring

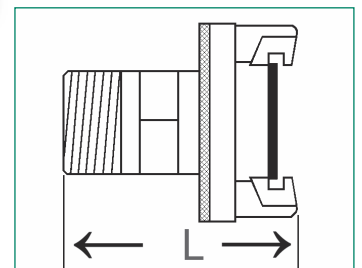

Item-No.:	Conn.:	DN:	Length:	Packing unit:
KTW-A seal black	spout		L	
33406 1	3/4"	20	61,3	5/50
33407 8	1"	25	65	5/50

Express coupling with lock nut made of brass, tailpiece

Suction and high pressure coupling for suction lines, absolutely tight and secured against loosening by locking ring

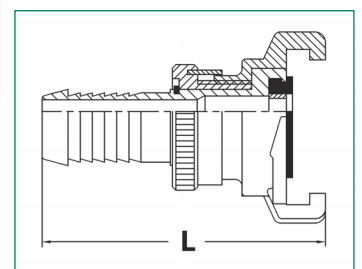

Item-No.:	Conn.:	DN:	Length:	Packing unit:
KTW-A seal black	spout		L	
33401 6	1/2"	15	74	5/80
33402 3	3/4"	20	77	5/80
33403 0	1"	25	81,5	5/50
33404 7	1 1/4"	32	84	5/50

Spare parts for express couplings made of brass with lock nut



Rubber seal for suction coupling, material: **NBR, black**.

Item-No.:	Connection:	Packing unit:
33905 9	Ø 33,5 x Ø 21 x 13,4	100/3000
Brass ring for suction coupling		
33906 6	Ø 21,5 x Ø 19,5 x 4	100/3000

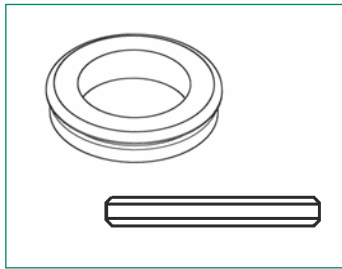

Replacement seal for express couplings made of brass



Fits all quick couplings with cam width 40 mm. KTW-A and W-270 tested. Suitable for drinking water.

Item-No.:	Connection:	Packing unit:
Material: NBR, black		
33902 8	Ø 35,5 x Ø 32,5 x 12	100/2000
Material: FKM, green		
33902-FKM	Ø 35,5 x Ø 32,5 x 12	100/ 500

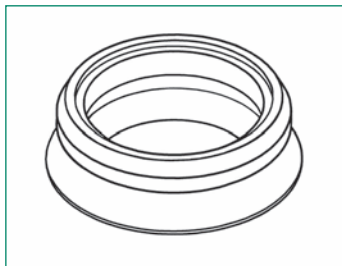

Flat seal



For express couplings with female thread. Material: **NBR, black**. KTW-A and W-270 tested. Suitable for drinking water.

Item-No.:	Female thread:	Connection:	Packing unit:
33910 3	3/8"	Ø 16,5 x Ø 10,5 x 2	500/ 5000
33911 0	1/2"	Ø 21,5 x Ø 14 x 2	500/10000
33912 7	3/4"	Ø 27 x Ø 20 x 2	500/ 7000
33913 4	1"	Ø 33,5 x Ø 24 x 2	250/ 4000
33914 1	1 1/4"	Ø 44 x Ø 32 x 2	100/ 5000
33915 8	1 1/2"	Ø 48 x Ø 37 x 3	100/ 5000

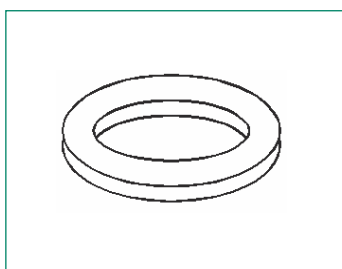

Series MSC

Express claw couplings of forged brass, internal cam distance 40 mm, PN 10, to match the current systems, NBR-seal, is suitable for drinking water, seals red: couplings according to the German Drinking Water Ordinance, temperature range: app. – 30°C to + 90°C, bursting pressure: min. 30 bar (according to DVGW VP-550) at 20°C

Coupling with tailpiece

Item-No.:	Conn.:	DN:	Length:	Packing unit:
DVGW seal red			L	
33070 4	3/8"	10	49	10/ 160
33071 1	1/2"	15	48,5	10/ 160
33079 7	5/8"	15	52,5	10/ 240
33072 8	3/4"	20	52,5	10/ 100
33073 5	1"	25	58	10/ 80
33074 2	1 1/4"	32	70	10/ 80
33075 9	1 1/2"	40	73	10/ 50

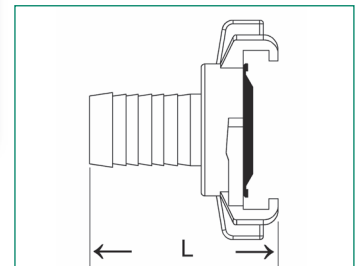

Coupling, female threaded

Item-No.:	Conn.:	DN:	Length:	Packing unit:
DVGW seal red			L	
33170 1	3/8"	10	32	10/ 160
33171 8	1/2"	15	32	10/ 160
33172 5	3/4"	20	32	10/ 160
33173 2	1"	25	33	10/ 160
33174 9	1 1/4"	32	38	10/ 100
33175 6	1 1/2"	40	40	10/ 100

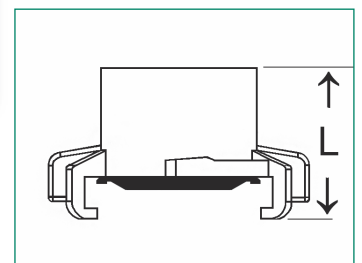

Coupling, male threaded

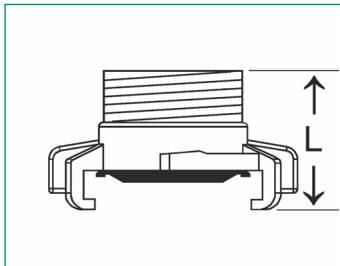

Item-No.:	Conn.:	DN:	Length:	Packing unit:
DVGW seal red			L	
33270 8	3/8"	10	33	10/160
33271 5	1/2"	15	33	10/160
33272 2	3/4"	20	33	10/160
33273 9	1"	25	33	10/160
33274 6	1 1/4"	32	38	10/100
33275 3	1 1/2"	40	40	10/100

Blind cap

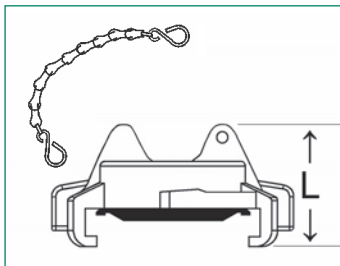

Fits all sizes, hole for attaching a chain (without chain)

Item-No.:	DN:	Conn. for borehole:	Length:	Packing unit:
DVGW seal red			L	
33907 3	40	2,5	33	10/160
33901-Kette		chain for 33907	-	

Coupling with tailpiece, rotating

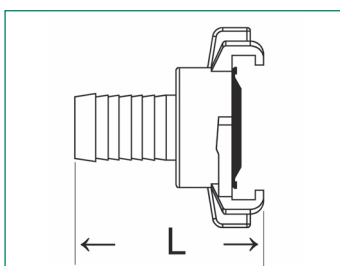

2-piece tube made of brass, spout 360° rotating, very light coupling

Item-No.:	Conn.:	DN:	Length:	Packing unit:
DVGW seal red	spout		L	
33015 5	1/2"	15	55,5	10/100
33016 2	3/4"	20	58,5	10/100
33017 9	1"	25	61,5	10/ 80

Express coupling with female coupling

Item-No.:	Conn.:	DN:	Length:	Packing unit:
DVGW seal red			L	
33241 8	1/2"	13	55	6/96
33242 5	3/4"	19	56	6/96
33243 2	1"	25	57	6/60

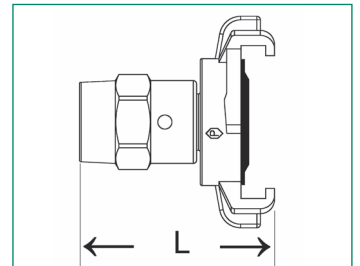

Express coupling with lock nut made of brass, male threaded

Suction and high pressure coupling with male thread (wrench size 24) for suction lines, absolutely tight and secured against loosening by protecting ring

Item-No.:	Conn.:	DN:	Length:	Packing unit:
DVGW seal red	spout		L	
33476 4	3/4"	20	61,3	5/80
33477 1	1"	25	65	5/50

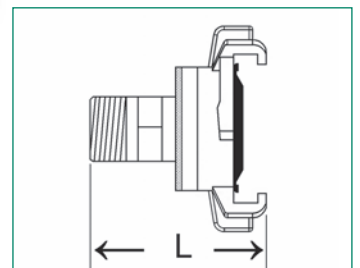

Express coupling with lock nut made of brass, tailpiece

Suction and high pressure coupling for suction lines, absolutely tight and secured against loosening by locking ring

Item-No.:	Conn.:	DN:	Length:	Packing unit:
DVGW seal red	spout		L	
33401 6	1/2"	15	78	5/80
33402 3	3/4"	20	83	5/80
33403 0	1"	25	87	5/50
33404 7	1 1/4"	32	90	5/50

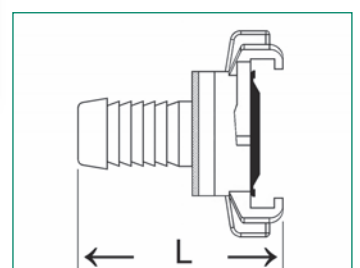
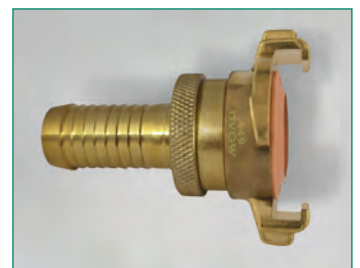

Spare parts for express couplings made of brass with lock nut



Rubber seal for suction coupling, material: **NBR, red.** KTW-A and W-270 tested. Suitable for drinking water. Couplings according to the German Drinking Water Ordinance.

Item-No.:	Connection:	Packing unit:
33905-KTW-rot	Ø 33,5 x Ø 21 x 13,4	100/3000
Brass ring for suction coupling		
33906 6	Ø 21,5 x Ø 19,5 x 4	100/3000

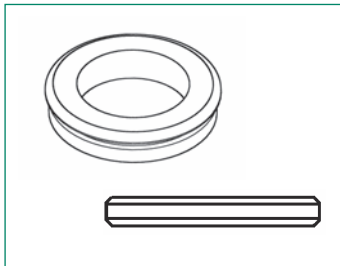

Replacement seal for express couplings made of brass



Fits all quick couplings with cam width 40 mm, material: **NBR, red.** KTW-A and W-270 tested. Suitable for drinking water. Couplings according to the German Drinking Water Ordinance.

Item-No.:	Connection:	Packing unit:
33902-KTW-rot	Ø 35,5 x Ø 32,5 x 12	100/2000

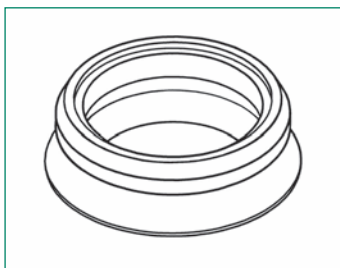

Rubber flat seal

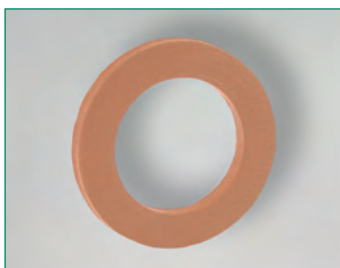

For express couplings with female thread, material: **NBR, red.** KTW-A and W-270 tested. Suitable for drinking water. Couplings according to the German Drinking Water Ordinance.

Item-No.:	Spout:	Connection:	Packing unit:
DVGW seal red			
33910-rot	3/8"	Ø 16,5 x Ø 10,5 x 2	500/ 5000
33911-rot	1/2"	Ø 21,5 x Ø 14 x 2	500/10000
33912-rot	3/4"	Ø 27 x Ø 20 x 2	500/ 7000
33913-rot	1"	Ø 33,5 x Ø 24 x 2	250/ 4000
33914-rot	1 1/4"	Ø 44 x Ø 32 x 2	100/ 5000
33915-rot	1 1/2"	Ø 48 x Ø 37 x 3	100/ 5000

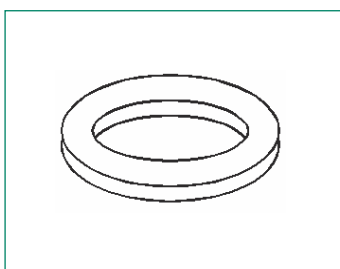

Hat-filter for express couplings made of brass

For inserting into express coupling made of brass, size 1" to 1 1/2", fine-mesh stainless steel strainer for filtering slightly dirty liquids

Item-No.:	Length: L	Packing unit:
33903 5	26	9/1674

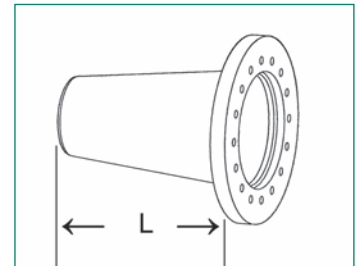

Brass spray nozzle, "Siro", with express coupling

Item-No.:	Connection:	Length: L	Packing unit:
34941 6	1/2"	76	5/120
34942 3	3/4"	76,5	5/120
34943 0	1"	86	5/ 50

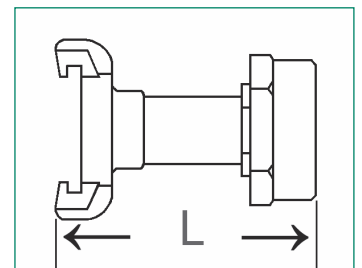
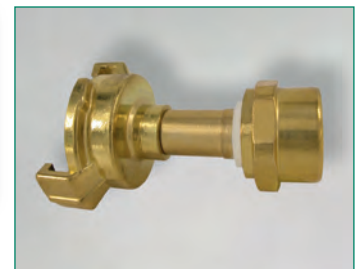

Brass spray nozzle, heavy version, with express coupling

Item-No.:	Connection:	Length: L	Packing unit:
33511 2	1/2"	82 - 86	6/60
33512 9	3/4"	92 - 99	5/50
33513 6	1"	104 - 113	4/40

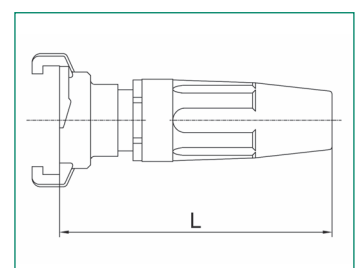
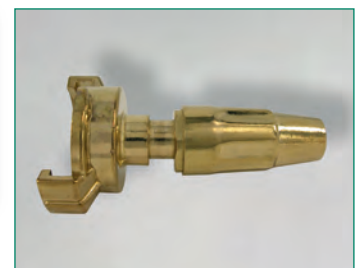

Y-connector made of brass



With 3 express couplings, suitable for all sizes of 3/8" to 1 1/2"

Item-No.:	Item-No.:	Length:		Packing unit:
		L1	L2	
KTW-A seal black 34993 5	DVGW seal red 34997 3	76	60	3/30

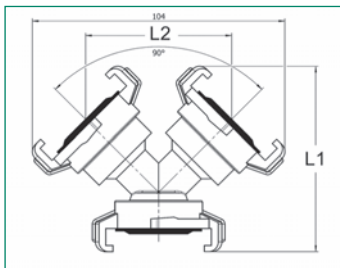

Twin tap connector made of brass



2 outlets individually adjustable by ball valves, 3 express couplings

Item-No.:	Length: L1	L2	Packing unit:
53306 8	127	88	6/120

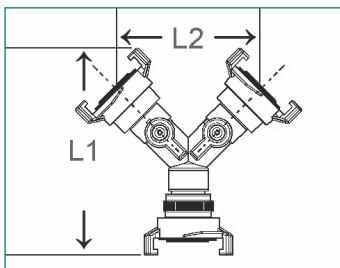

Two-way stopcock made of brass



With 3 express couplings, 2 outlets individually adjustable by upper valve parts

Item-No.:	Nominal diameter:	Length:		Pack. unit:
		L1	L2	
34996 6	15	124	123	5/60

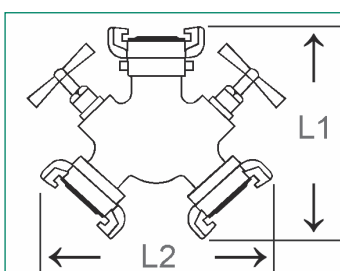

Series EST

**Express claw couplings, stainless steel (1.4401),
internal cam distance 40 mm, to match the current systems, FKM-seal,
temperature range: app. – 20°C to + 200°C, bursting pressure: min. 30 bar**

Coupling with tailpiece

Item-No.:	Connection:	Length: L	Packing unit:
33001-1.4401	1/2"	48,5	10/200
33002-1.4401	3/4"	52,5	10/150
33003-1.4401	1"	58	10/150
33004-1.4401	1 1/4"	66,5	-/-

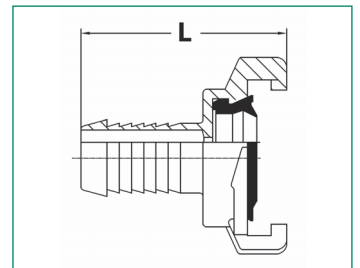
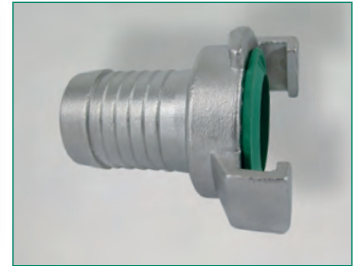

Coupling, female threaded

Item-No.:	Connection:	Length: L	Packing unit:
33101-1.4401	1/2"	32	10/170
33102-1.4401	3/4"	32	10/200
33103-1.4401	1"	33	10/200

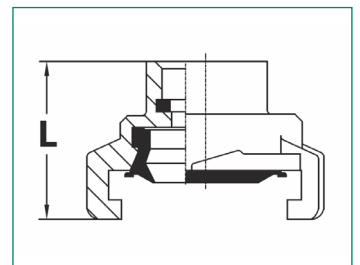

Coupling, male threaded



Item-No.:	Connection:	Length: L	Packing unit:
33201-1.4401	1/2"	33	10/200
33202-1.4401	3/4"	33	10/170
33203-1.4401	1"	33	10/150

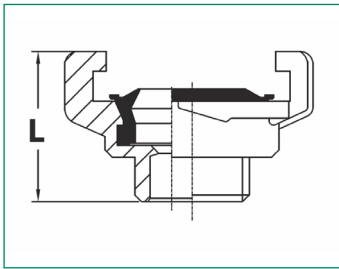

Blind cap

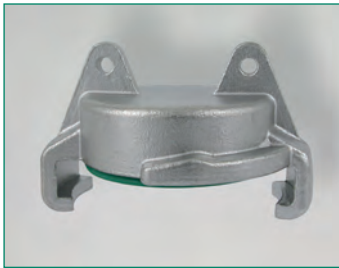

Fits all sizes, hole for attaching a chain (without chain)

Item-No.:	Conn. for borehole:	Length: L	Packing unit:
33901-1.4401	2,5	33	10/200

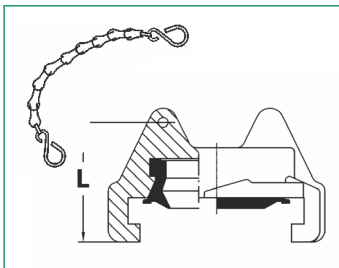

Replacement seal for express couplings made of brass



Fits all quick couplings with cam width 40 mm. Material: **FKM, green**. KTW-A and W-270 tested. Suitable for drinking water.

Item-No.:	Connection:	Packing unit:
33902-FKM	Ø 35,5 x Ø 32,5 x 12	100/500

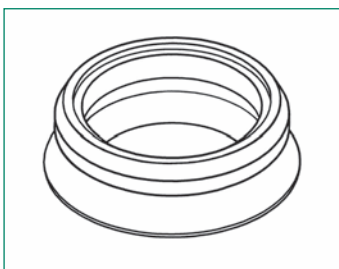

Express claw couplings of forged brass, internal cam distance 41 mm, heavy version (French model)

Coupling with tailpiece

Item-No.: without sealing	Item-No.: with sealing	Hose tail mm:	Length: L	Packing unit:
33080 3	33080-D	7/ 9 (1/4")	65	10/ 250
33081 0	33081-D	8/10	65	10/ 140
33084 1	33084-D	9/ 11	65	10/ 150
33085 8	33085-D	10/ 12	65	10/ 140
33086 5	33086-D	11/ 13	65	10/ 150
33087 2	33087-D	13/16	65	10/ 140
33089 6	33089-D	16/18 (5/8")	65	10/ 120
33082 7	33082-D	19/ 21 (3/4")	65	10/ 110
33083 4	33083-D	25/27 (1")	65	10/ 100

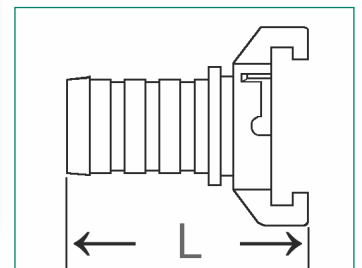

Coupling, female threaded

Item-No.: without sealing	Item-No.: with sealing	Connection:	Length: L	Packing unit:
33189 3	33189-D	1/4"	33	10/ 160
33180 0	33180-D	3/8"	33	10/ 180
33181 7	33181-D	1/2"	32	10/ 160
33182 4	33182-D	3/4"	34,5	10/ 160
33183 1	33183-D	1"	36	10/ 140
33184 8	33184-D	1 1/4"	43,5	10/ 80

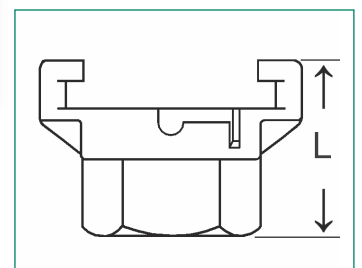

Coupling, male threaded

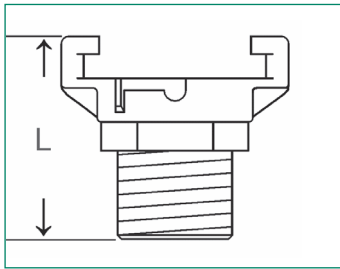

Item-No.: without sealing	Item-No.: with sealing	Connection:	Length: L	Packing unit:
33289 0	33289-D	1/4"	39	10/200
33280 7	33280-D	3/8"	39	10/180
33281 4	33281-D	1/2"	37	10/160
33282 1	33282-D	3/4"	38	10/150
33283 8	33283-D	1"	39	10/140
33284 5	33284-D	1 1/4"	43,5	10/100

Blind cap

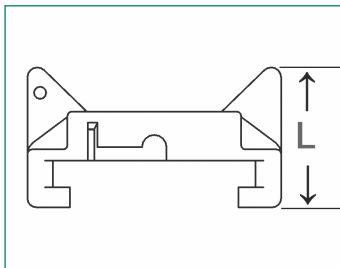

Fits all sizes, hole for attaching a chain (without chain), french model

Item-No.: without sealing	Item-No.: with sealing	Borehole:	Length: L	Packing unit:
33909 7	33909-D	3,5 mm	43,5	10/160

Replacement seal for express couplings made of brass

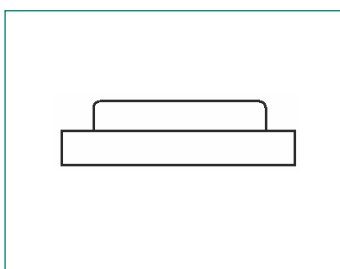
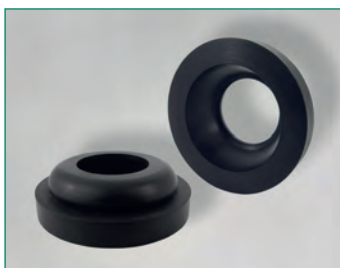

For couplings 41 mm, material: **NBR, black**, water and oil resistant

Item-No.:	Connection:	Packing unit:
33908 0	Ø 34,5 x Ø 16,5 x 10,5	100/1000

Fire hose nose

Coupling: quick German coupling 1"
Materials: aluminium and plastics

Item-No.:	Type:	Total length: L	Notch distance:	Packing unit:
34973 7	D	290 mm	-/-	1/-

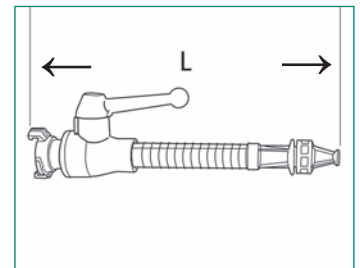

Fire hose nose

Coupling: Storz adapter
Materials: aluminium and plastics

Item-No.:	Type:	Total length: L	Notch distance:	Packing unit:
34974 4	C	450 mm	66	1/-

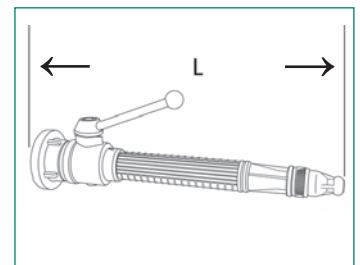
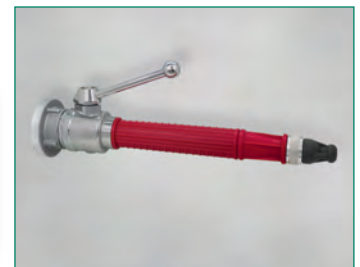

Y-distributor with valve shut-off and C-couplings: system „Storz“

incl. screwable T-carrying handle

Item-No.:	Storz-size: Entrance x exit	Length: L	Lug spacing:	Pack. unit:
33872 4	75-B/89 x 2 x 52-C/66			1/-
Replacement carrying handle				
33872-01				1/-



Suction coupling system „Storz“ for hose

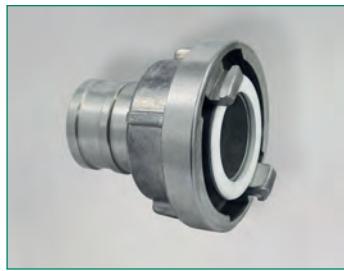

Quick coupling made of aluminium

Item-No.:	Hose:	Internal diameter: mm	Storz-size:	Lug spacing:	Packing unit:
33803 8	1"	25	25-D	31	1/-
33803-66	1"	25	52-C	66	1/-
33804 5	1 1/4"	32	52-C	66	1/-
33805 2	1 1/2"	38	52-C	66	1/-
33806 9	2"	52	52-C	66	1/-
33808 3	3"	75	75-B	89	1/-
33809 0	4"	100	110-A	133	1/-

Fixed coupling with male thread; system „Storz“

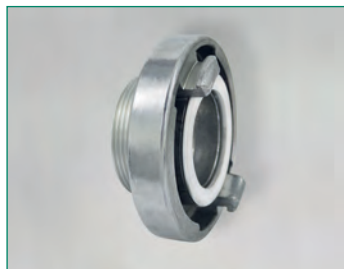

Quick coupling made of aluminium

Item-No.:	Male thread:	Male: mm	Storz-size:	Lug spacing:	Packing unit:
33823 6	G 1"	33	25-D	31	1/-
33823-66	G 1"	-	52-C	66	1/-
33824-66	G 1 1/4"	42	52-C	66	1/-
33825-66	G 1 1/2"	48	52-C	66	1/-
33826 7	G 2"	60	52-C	66	1/-
33826-89	G 2"	-	75-B	89	1/-
33827 4	G 2 1/2"	75	52-C	66	1/-
33827-89	G 2 1/2"	75	75-B	89	1/-
33828 1	G 3"	88	75-B	89	1/-
33829 8	G 4"	113	110-A	133	1/-
33829-412	G 4 1/2"	-	110-A	133	1/-

Quick coupling made of aluminium

Fixed coupling with female thread; system „Storz“

Item-No.:	Female thread:	F: mm	Storz-size:	Lug spacing:	Packing unit:
33812 0	G 3/4"	25	25-D	31	1/-
33813 7	G 1"	31	25-D	31	1/-
33813-66	G 1"	-	52-C	66	1/-
33814 4	G 1 1/4"	40	52-C	66	1/-
33815 1	G 1 1/2"	45	52-C	66	1/-
33816 8	G 2"	57	52-C	66	1/-
33816-89	G 2"	-	75-B	89	1/-
33817 5	G 2 1/2"	73	52-C	66	1/-
33817-89	G 2 1/2"	73	75-B	89	1/-
33818 2	G 3"	86	75-B	89	1/-
33819 9	G 4"	111	110-A	133	1/-
33819-115	G 4"	-	100	115	1/-

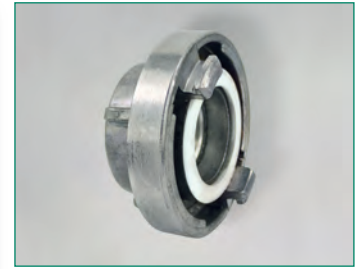

Reduction piece, system „Storz“

Quick coupling made of aluminium

Item-No.:	Storz-size:	Lug spacing:	Packing unit:
33842 7	52-C/25-D	66/31	1/-
33843 4	75-B/52-C	89/66	1/-
33844 1	110-A/75-B	133/89	1/-

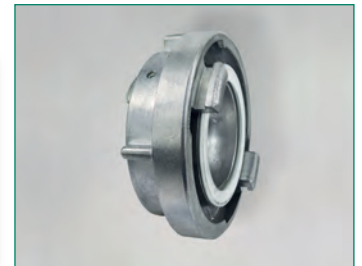

Adapter with quick coupling, system „Storz“

Aluminium

Item-No.:	Storz-size:	Lug spacing:	Packing unit:
33848-66	52-C/1 1/2"	66/40	1/-



Blindcoupling, system „Storz“



Aluminium, with chain

Item-No.:	Storz-size:	Lug spacing:	Packing unit:
33891 5	25-D	31	1/-
33892 2	52-C	66	1/-
33893 9	75-B	89	1/-
33894 6	110-A	133	1/-

Repair sleeve, system „Storz“



Aluminium

Item-No.:	Storz-size:	Ø mm	Lug spacing:	Packing unit:
33853 3	52-C	52		1/-
33858 8	75-B	75		1/-

Coupling spanner, system „Storz“



Malleable cast iron, painted red

Item-No.:	Storz-size: A-B-C	Ø mm	Lug spacing:	Packing unit:
33862 5	110-75-52			1/-

Joint, system „Storz“

without illu., NBR

Item-No.:	Storz-size:	Ø mm	Lug spacing:	Packing unit:
33950	25-D		31	-/-
33951 6	75-B		89	-/-
33952 3	52-C		66	-/-
33954	110-A		133	-/-

Spray nozzles made of brass

Heavy version with hose tail

Item-No.:	Hose tail:	Length: L	Packing unit:
33611 9	1/2"	88 - 93	12/120
33612 6	3/4"	103 - 110	8/ 80
33613 3	1"	126 - 135	4/ 40

Brass spray nozzle

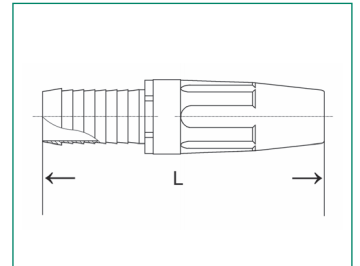
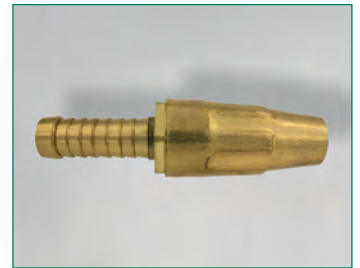

Professional version with hose tail, extended hosed tail with increased end rib for better hose seat, continuously adjustable

Item-No.:	Hose tail:	Length: L	Packing unit:
S-2448	3/4"	115	5/100

Brass spray nozzle

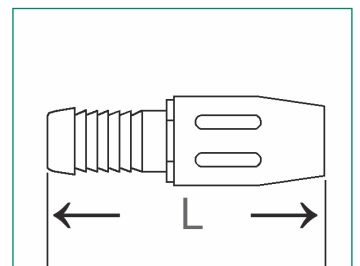

With rotating head and hose tail

Item-No.:	Hose tail:	Length: L	Packing unit:
34921 8	1/2"	67	10/300
34922 5	3/4"	68,8	10/100
34923 2	1"	90	6/ 60

Brass spray nozzle, „Siro“

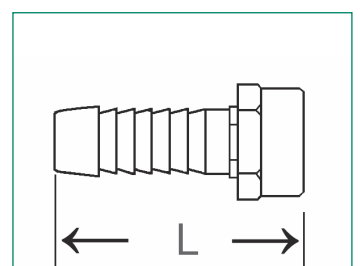

Brass spray nozzle, „Maxi“

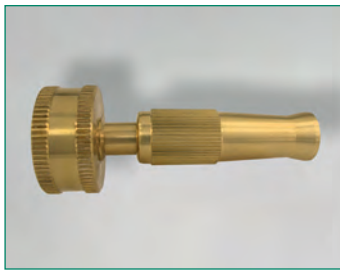

Medium-weight version with 3/4" female thread

Item-No.:	Connection:	Length: L	Packing unit:
34933 1	3/4"	L 3"	15/150
34934 8	3/4"	L 4"	-/240
34935 5	3/4"	L 3 1/2"	-/240

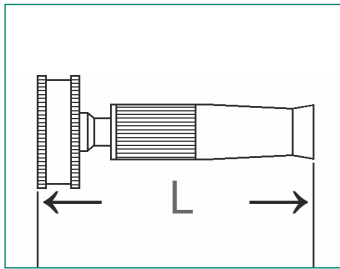

Brass spray nozzle, „Maxi“

As before, but with mounted hose connector



Item-No.:	Item-No.:	Connection:	Length:	Pack. unit:
	Hose connector	Hose tail / Length L	L	
34926 3	34985 0	Hose tail conical: 3/4" to 5/8", L 3"		-/240
34927 0	34169 4	1", L 3"	107,5	-/240
34928 7	34152 6	3/4", L 3"	100	10/100
34931 7	34146 5	5/8", L 3"	98,5	10/100
34929 4	34985 0	Hose tail conical: 3/4" to 5/8", L 3 1/2"	121,5	-/250
34930 0	34169 4	1", L 3 1/2"		-/200
34938 6	34152 6	3/4", L 3 1/2"		-/200
34939 3	34146 5	5/8", L 3 1/2"	107	-/200
34936 2	34152 6	3/4", L 4"		-/200
34937 9	34146 5	5/8", L 4"	122	8/ 80

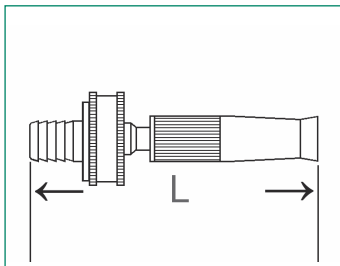

Brass spray nozzle, „Alpha“

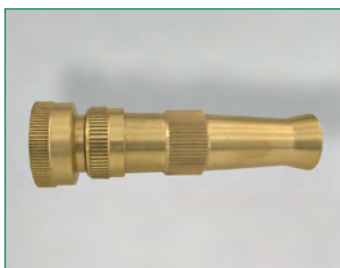

Heavy version with 3/4 " female thread

Item-No.:	Item-No.:	Connection:	Length: L	Pack. unit:
34914 0		3/4"		10/80

As before, but with mounted pipe socket

Item-No.:	Item-No.:	Connection:	Length: L	Pack. unit:
	Hose connector	Hose tail	L	
34915 7	34169 4	1"	132,5	-/140
34916 5	34152 6	3/4"		-/140
34917 1	34146 5	5/8"		-/140
34919 5	34985 0	Spout conical: 3/4" to 5/8"		-/140

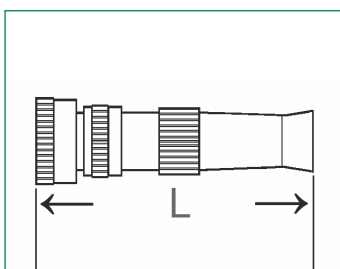

Brass nozzle

Plain brass

Item-No.:	Connection:	Length: L	Pack. unit:
S-2553	3/4" x 65 mm	65	10/240

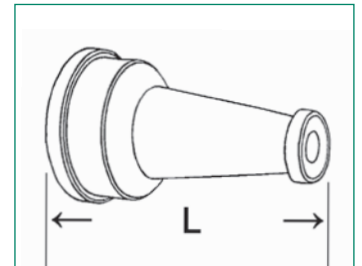

Brass spray nozzle (model „SWISS“)

Plain brass, hexagon nut with female thread and seal

Item-No.:	Connection f:	Length: L	Packing unit:
34952 2	3/4"	103,5	-/100
34953 9	1"	103	-/ 90

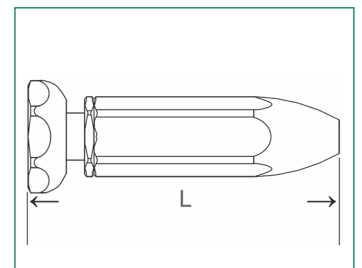

Brass spray nozzle (model „SWISS“)

Plain brass, knurled nut with female thread and seal

Item-No.:	Connection f:	Length: L	Packing unit:
34913 3	3/4"	87,5	-/200

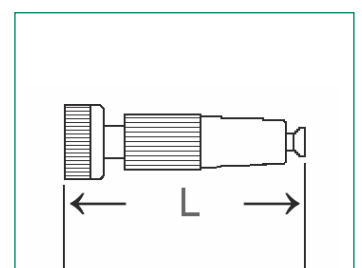
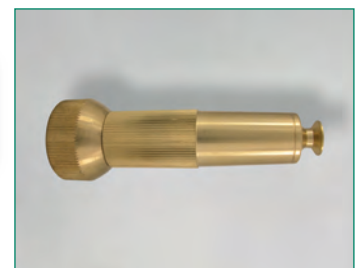

Brass spray nozzle with hose tail (model „SWISS“)



Item-No.:	Connection spout:	Length: L	Packing unit:
34955 3	13 mm	119	-/150
34956 0	16 mm	112	-/140
34957 7	19 mm	112	-/125

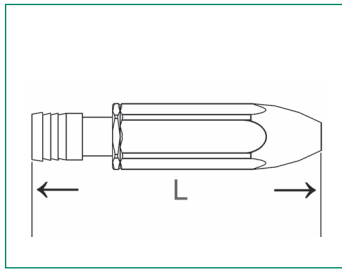

Garden hand shower



Made of aluminium, solid version, plastic-coated, female threaded connection 3/4 "with seal – adjustable to 6 operating modes.

With mounted brass express coupling.

Types of radiation: ⇨ normal spray
⇨ shower spray
⇨ jet spray
⇨ fog jet
⇨ fan jet
⇨ soft spray

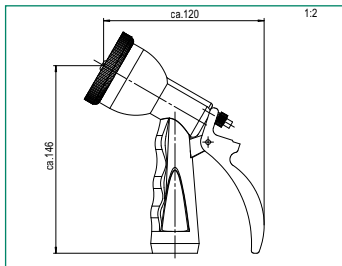

Item-No.:	Connection:	Packing unit:
33093 3	3/4" female thread	1/48
without plug-in coupling		
33095 7	3/4" female thread	1/48

Garden spray pistol



Made of aluminium, solid version, plastic-coated, female threaded connection 3/4 " with seal, adjustable from spray to full beam. With mounted brass express coupling.

Item-No.:	Connection:	Packing unit:
33092 6	3/4" female thread	1/48
without plug-in coupling		
33094 0	3/4" female thread	1/48

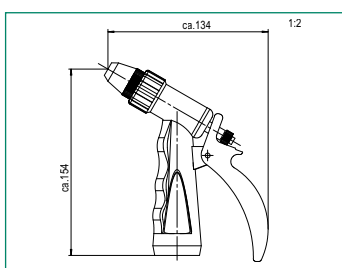

Replacement flat seal for 33093 + 33092

without illustration, material NBR

Item-No.:	Connection:	Packing unit:
33063 6	3/4"	-/2500

Cleaning pistol

Cleaning pistol for professional use, female thread 1/2", body made of brass CW617N, EPDM rubber coating, material and sealings according to the drinking water ordinance, jet type adjustable from fine spray to full flow, lockable for continuous operation, water temperature up to + 50°C, operating pressure: max. 24 bar, flow volume: 25 l/min. at 5 bar

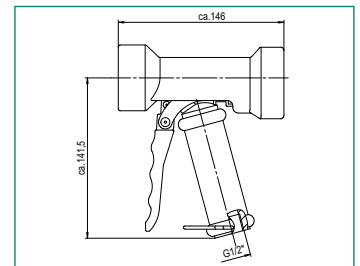

Item-No.:	Connection:	Packing unit:
34971 3	1/2" f	-/12

Brass shower head

Plain brass, female threaded, Ø 150 mm, boring Ø 0,8 mm, rubber protection ring

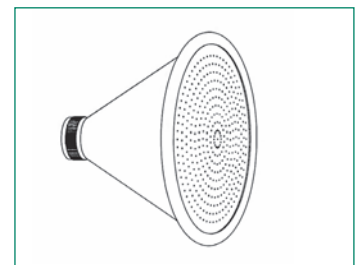

Item-No.:	Spout:	Length: L	Packing unit:
33528 0	3/4"	117 mm	1/36

Shower head

Aluminium, fan beam, female threaded with seal

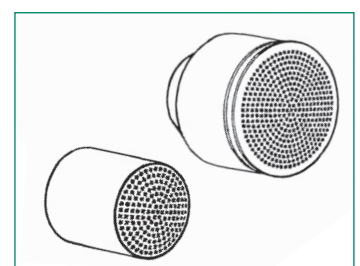
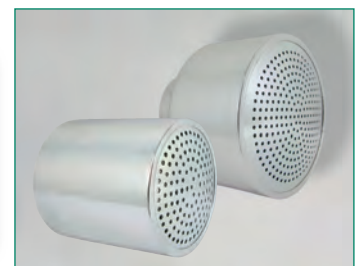

Item-No.:	Spout:	Ø Shower:	Ø Holes:	Packing unit:
33531 0	3/4"	52 mm, aluminium	0,7 mm	1/100
33533 4	3/4"	52 mm, aluminium	1 mm	1/100
33537 2	3/4"	30 mm, aluminium	1 mm	1/100

Outlet pipes

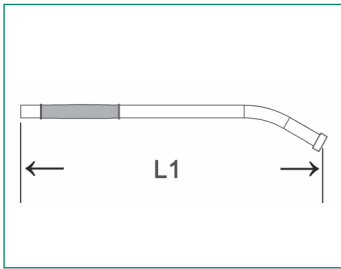

Aluminium, Ø tube 19 mm

Item-No.: with plastic handle	Item-No.: without plastic handle	Connecting threads: Aluminium	Length: L1	Packing unit:
33542 6	33543 3	AG x IG 3/4"	20 cm	-/-
33520 4	33521 1	AG x IG 3/4"	40 cm	1/50
33522 8	33523 5	AG x IG 3/4"	60 cm	1/50
33524 2	33525 9	AG x IG 3/4"	90 cm	1/50
33526 6	33527 3	AG x IG 3/4"	120 cm	1/40

Plastic handle for outlet pipes

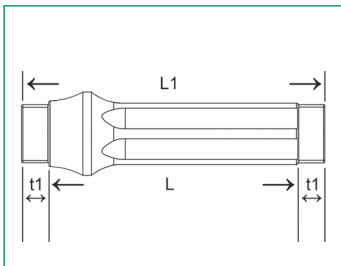

Plastic, Ø 19 mm

Item-No.:	Con.:	Length: L	Length: L1	Thread: t1	Thread: t2	Pack. unit:
33540 2	3/4"	115 mm	139 mm	12	12	-/500

Filter sieve

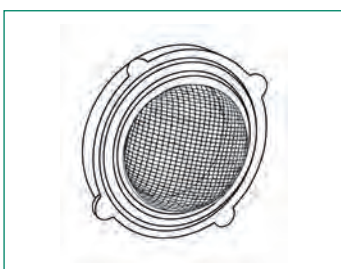

Filter sieves for outlet pipes

Item-No.:	Con.:	Length: L	Pack. unit:
3352x-Filter	3/4"		-/12

Brass ball valve for watering devices

Nickel plated, PN 25, red swivel handle, reduced flow, f/m, flat sealing

Item-No.:	Conn.:	Threadlength:		Length:				Packing unit:
		t1	t2	L	Ø	H	LH	
53212-11018	3/4"	10	12	53,5	29,5	33	39,5	-/60

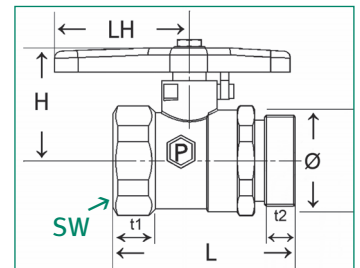
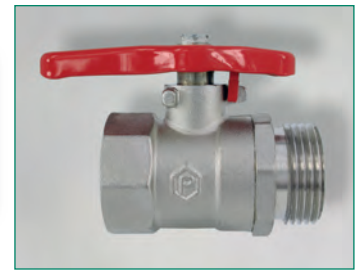

Casting unit set

Set consists of: brass quick coupling, nickel plated ball valve with red swivelling handle, aluminium rod Ø 19 mm with handle (plastic) and showerhead

Item-No.:	Conn.:	Ø Shower:	Ø Hole:	Rod length L:	Pack. unit:
33550 1	3/4"	52 mm, Alu	0,7 mm	400 mm	1/-
33552 5	3/4"	52 mm, Alu	0,7 mm	600 mm	1/-
33554 9	3/4"	52 mm, Alu	0,7 mm	900 mm	1/-
33556 3	3/4"	52 mm, Alu	0,7 mm	1200 mm	1/-

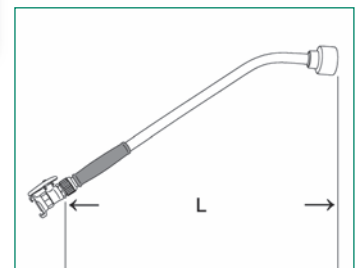

Casting unit set

Set consists of: brass quick coupling, plastic handle Ø 19 mm, nickel plated ball valve with red swivelling handle, aluminium rod Ø 19 mm with showerhead

Item-No.:	Conn.:	Ø Shower:	Ø Hole:	Rod length L:	Pack. unit:
33559 4	3/4"	52 mm, Alu	0,7 mm	200 mm	1/-
33551 8	3/4"	52 mm, Alu	0,7 mm	400 mm	1/-
33553 2	3/4"	52 mm, Alu	0,7 mm	600 mm	1/-
33555 6	3/4"	52 mm, Alu	0,7 mm	900 mm	1/-
33557 0	3/4"	52 mm, Alu	0,7 mm	1200 mm	1/-

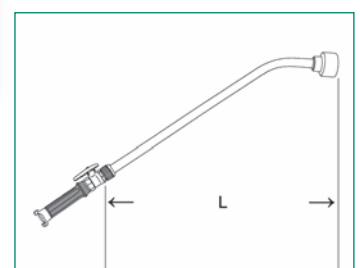

Taps made of brass

Tap

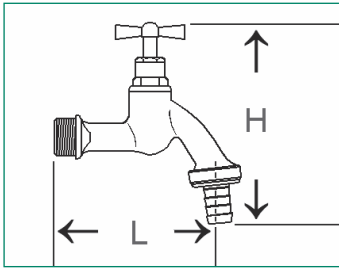

Upper part with double O-ring, including hose connection, optionally made of plastic or metal sheet

Item-No.:	Item-No.:	Conn.:	Execution:	Length:	Height:	Pack. unit:
Spout plastic	Spout metal sheet			L	H	
52121-N	52121-N-B	1/2"	matt-chrome plated	91	117	5/ 60
52122-N	52122-N-B	3/4"	matt-chrome plated	92	120	5/ 40
-	52123-N-B	1"	matt-chrome plated	93	122	5/ 5
52131-N	52131-N-B	1/2"	polish. chrome-pla.	91	117	5/ 60
52132-N	52132-N-B	3/4"	polish. chrome-pla.	92	120	5/ 40
52141-N	52141-N-B	1/2"	blank-polished	91	117	5/ 60
52142-N	52142-N-B	3/4"	blank-polished	92	120	5/ 40
52151-N	52151-N-B	1/2"	blank-sandblasted	91	117	5/ 60
52152-N	52152-N-B	3/4"	blank-sandblasted	92	120	5/ 40

Upper valve part with T-handle

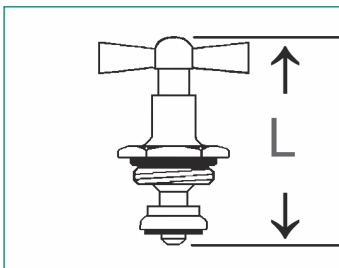

Made of brass with double O-ring, without non-return valve

Item-No.:	Connection:	Execution:	Length: L	Pack. unit:
52125 6	1/2"	matt-chrome plated	58	50/400
52126 3	3/4"	matt-chrome plated	54	35/280
52135 5	1/2"	polished chrome-plated	58	50/200
52136 2	3/4"	polished chrome-plated	54	35/ 140
52145 4	1/2"	blank-polished	58	50/200
52146 1	3/4"	blank-polished	54	35/ 140
52155 2	1/2"	blank-sandblasted	58	50/400
52156 3	3/4"	blank-sandblasted	54	35/280

Tap, lockable

Like 52121 or 52131, but with lockable valve bonnet „Water Safe“

Item-No.:	Connection:	Execution:	Length: L	Pack. unit:
52124 9	1/2"	matt-chrome plated	92	1/-
52134 8	3/4"	polished chrome-plated	93	1/-

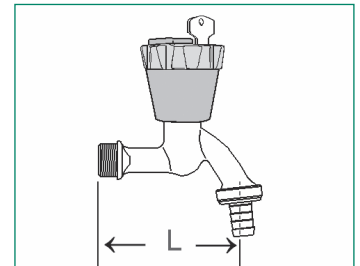

Valve bonnet „Water Safe“

Lockable valve top to outlet valves with T-handles

Item-No.:	Connection:	Execution:	Pack. unit:
52059 4	1/2"	Standard	1/50
52058 7	1/2"	with backflow preventer for taps with aerator	1/50

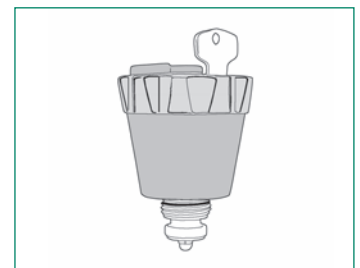

Tap

Tap with upper part for socket wrench, including socket wrench and hose connection

Item-No.:	Conn.:	Execution:	Length:	Height:	Pack. unit:
			L	H	
52051-N	1/2"	matt-chrome plated	92	110	5/ 60
52052-N	3/4"	matt-chrome plated	93	120	5/ 40
52053-N	1/2"	polished chrome-plated	92	110	5/ 60
52057 0		Key, loose	34,5	24	250/1000
52055 6	1/2"	Upper part for 52051 incl. key	48	63	50/ 200
52056 3	3/4"	Upper part for 52052 incl. key	57	72	35/ 280

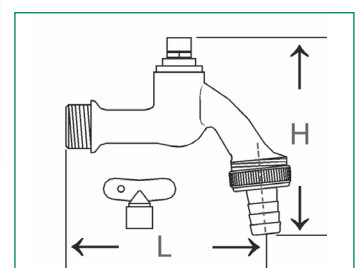

Socket wrench

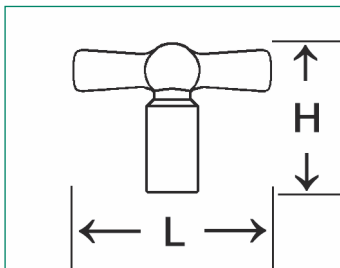

Loose, chrome plated brass, suitable for sanitary upper parts

Item-No.:	Execution:	Length:	Height:	Packing unit:
		L	H	
52057-11712	Key loose, internal polygon	44	33	50/400

Tap

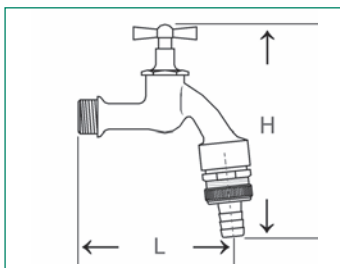

With T-handle and hose connection optionally made of plastic or metal sheet. With aerator according to DIN DVGW (size 1/2") and backflow preventer

Item-No.:	Spout plastic	Spout metal sheet	Connec.:	Execution:	Length:	Height:	Pack. unit:
					L	H	
52041 9			1/2"	matt-chrome plat.	92	140	5/60
52042 6			3/4"	matt-chrome plat.	93	145	4/28
52061 7			1/2"	poli. chrome-plat.	92	140	5/60
52062 4			3/4"	poli. chrome-plat.	93	145	4/28

Packed in single carton:

52041-K	52041-K-B	1/2"	matt-chrome plat.	92	140	1/60
52042-K	52042-K-B	3/4"	matt-chrome plat.	93	145	1/28
52061-K	52061-K-B	1/2"	poli. chrome-plat.	92	140	1/60
52062-K	52062-K-B	3/4"	poli. chrome-plat.	93	145	1/28

Tap

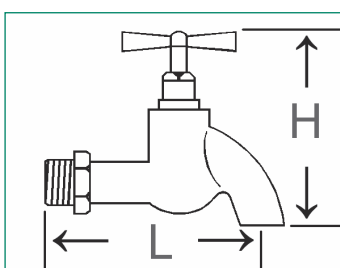

Smooth outlet

Item-No.:	Conn.:	Execution:	Length:	Height:	Pack. unit:
			L	H	
52091 4	1/2"	polished chrome-plated	95	82	5/120

Upper valve part with T-handle

Made of brass with a double O-ring and backflow preventer

Item-No.:	Conn.:	Execution:	Length: L	Pack. unit:
52046 4	1/2"	matt-chrome plated	55	10/300
52046-3/4	3/4"	matt-chrome plated	58	10/250
52066 2	1/2"	polished chrome-plated	55	10/180

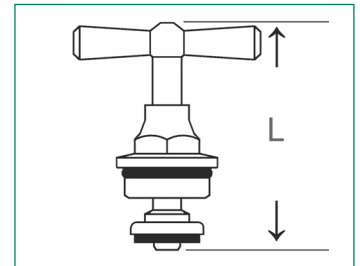

Like 52041 or 52061, but with lockable upper valve part „Water Safe“ (Item-No. 52059), with aerator according to DIN DVGW

Item-No.:	Conn.:	Execution:	Length: L	Height: H	Packing unit:
52045 7	1/2"	matt-chrome plated	92		1/-
52063 1	1/2"	polished chrome-plated	92		1/-

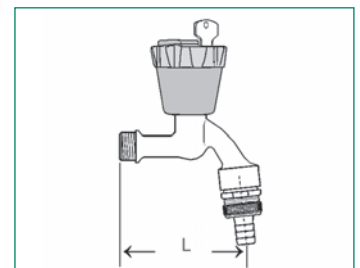

Like 52061, but with hose connection for plug system made of brass, with integrated drain plug to drain before the frost period

Item-No.:	Conn.:	Execution:	Length: L	Height: H	Packing unit:
52064 8	1/2"	polished chrome-plated	92	150	5/60

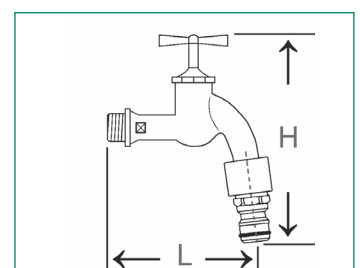

Tap water meter



Tap water meter with protective plastic cover, for connection to a drain valve with connection coupling with sealing holes, hose coupling, Qn 1.5, length 80 mm, temperature range up to 30 °C, rotatably, calibrated

Item-No.:	Dim. screw:	Dimension male thread:	Length:	Pack. unit:
52088 4	3/4" x 3/4"	1/2"	-	1/10
52089 1	3/4" x 1"	3/4"	-	1/10

Tap frost-proof „Frost-Tec“



With anti-freeze protection for the use in outdoor areas, matt chrome plated, fully adjustable mounting depth 240-410 mm, with fixing material

Item-No.:	Conn.:	Execution:	Length: L	Packing unit:
52096 9	1/2"	matt-chrome plated	273 - 443 mm	1/12

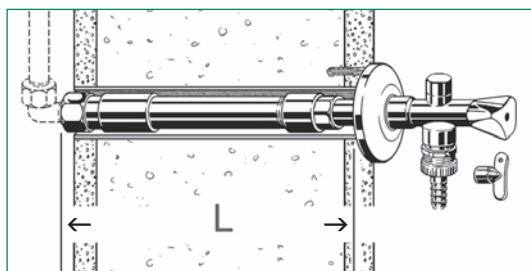

Plain brass, with hose coupling (french model)

Item-No.:	Connection:	Discontin.:	Length: L	Height: H	Packing unit:
52181-N	1/2"	1/2"	87	110	5/ 60
52182-N	1/2"	3/4"	97,5	110	5/ 60
52183-N	3/4"	3/4"	97,5	120	5/ 60
52184-N	3/4"	1"	97	120	4/ 32

matt-chrome plated, without metal hose coupling

52182-N-CR	1/2"	3/4"	97,5	110	5/ 60
35081-K	1/2"	3/4"			50/1500

Tap

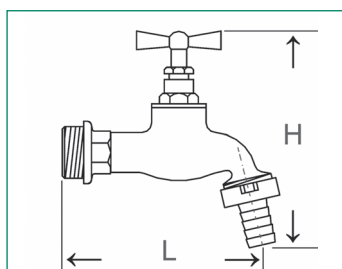

Replacement-upper part with stuffing box (without illustration)

Item-No.:	screw-in-thread	for Item-No.:	Length:	Packing unit:
52186 7	3/8"	52181-N	-	/400
52187 4	1/2"	52182-N	-	40/160
52187 4	1/2"	52183-N	-	40/160
52188 1	3/4"	52184-N	-	10/ 130

Tap

Tap made of brass with upper part for socket wrench (french model), chrome-plated, inclusive socket wrench, without hose connection



Item-No.:	Connection:	Discontin.:	Length:	Height:	Packing unit:
52180 5	1/2"	3/4"	L	H	5/60

Spare part to 52180 (without illustration):
upper valve part for outlet valve with socket wrench

Item-No.:	Connec.:	Execution:	Length:	Packing unit:
52055 6	1/2"	matt-chro. plat.	-	50/400

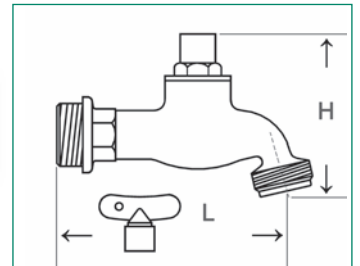

Tap made of brass, matt-chromed, with aerator, hose coupling, top with handwheel

Tap with handwheel



Item-No.:	Connec.:	Execution:	Length:	Height:	Packing unit:
52049 5	1/2"	3/4"	L	H	6/-

Replacement top with handwheel (without illustration)

Item-No.:	Connec.:	Execution:	Length:	Packing unit:
52291-52049	1/2"	matt-chromed	75	10/250

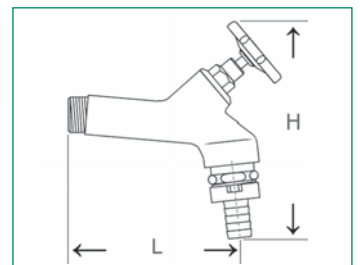

Made of polished brass, with long spout and lever, spout with spacer, including wall rose

Tap



Item-No.:	Connection:	Length:	Height:	Packing unit:
52070 9	1/2"	L	H	1/20

Replacement wall rosette:

52076-52070

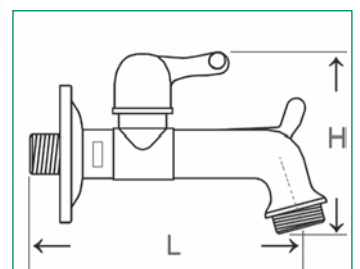

Nostalgic tap

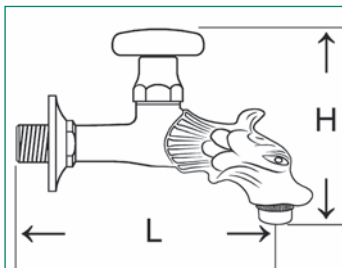

Made of polished brass, with **handwheel**, spout with spacer, with wall rose, threaded connection 1/2" with adapter nipple

Item-No.:	Connection:	Length: L	Height:	Packing unit:
52071 6	1/2"	146	125	1/20

Replacement:

Item-No.:	Description:	Packing unit:
52072 3	Upper valve part	-/-
52074 7	Handwheel	-/-
52075 4	Hexagon nut	-/2000
52076 1	Rosette	-/-
52077 8	Reducing nipple (3/8" x 3/4", m/m)	-/-

Nostalgic tap

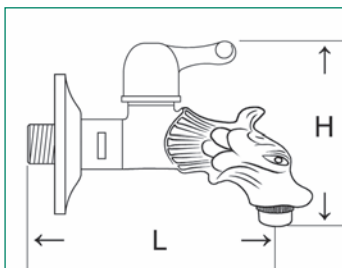

Made of polished brass, with **lever**, spout with spacer, with wall rose, threaded connection 1/2" with adapter nipple

Item-No.:	Connection:	Length: L	Height:	Packing unit:
52079 2	1/2"	130	100	1/40

Replacement:

52076-52070	Wall rosette
52077 8	Reducing nipple (3/8" x 3/4", m/m)

Tap

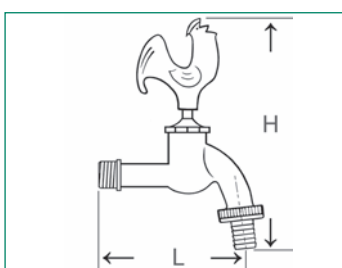
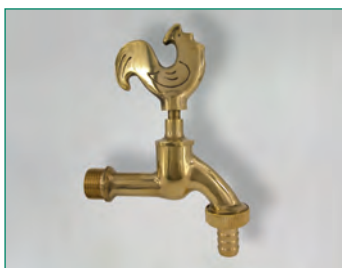

Made of polished brass, with upper part in form of a rooster, with hose connection

Item-No.:	Connection:	Length: L	Height: H	Packing unit:
52027 2	1/2"	95,5	160	5/60

Nostalgic taps

Brass patina, various animal motifs. Long distance to the wall, with massive brass wall rose, complete with hose connection 1/2" and spacer, individually packed in four-colour cartons

Item-No.:	Motif:	Motif-No.:	Connection:	Length:	Height:	Packing unit:
52170-E	Horsehead	1	1/2"	112	160	1/20
52171-E	Frog	2	1/2"	112	150	1/20
52172-E	Rooster	3	1/2"	112	160	1/20
52173-E	Bird	4	1/2"	112	145	1/20
52174-E	Cat	5	1/2"	112	160	1/20
52175-E	Fish	6	1/2"	112	160	1/20
52176-E	Duck	7	1/2"	112	135	1/20

Replacement seal for 52170-76, flat rubber seal

52179 9

Ø 5 x Ø 12 x 3,5 mm

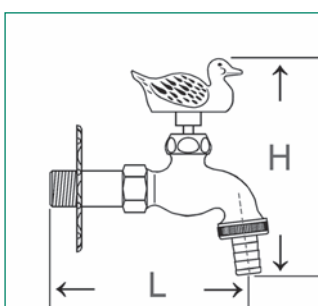
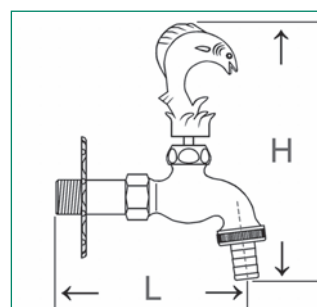
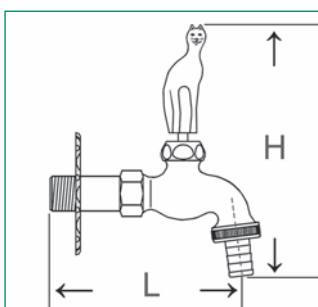
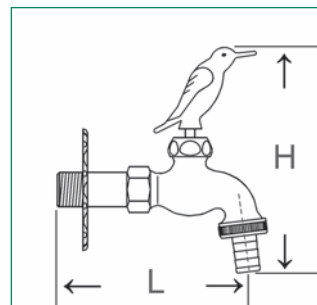
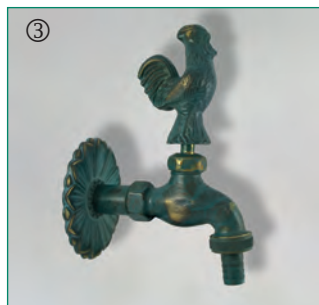
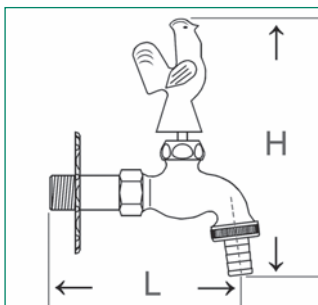
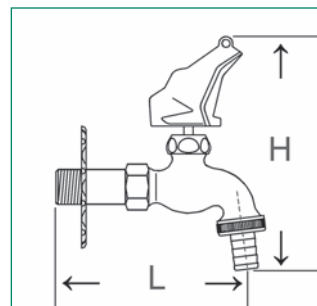
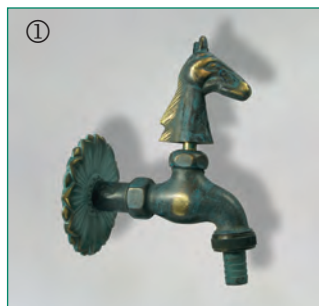
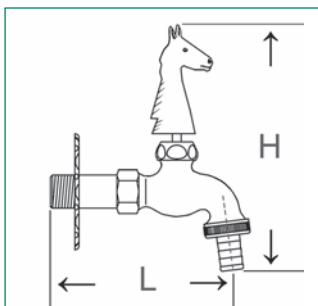

Bib tap

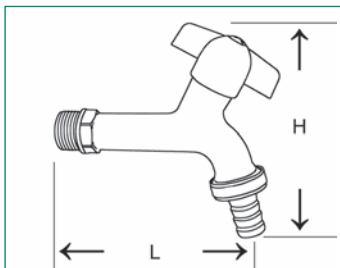

Valve body/handle made of PA6, RoHS- (Kat.2) / REACH-compliant, o-ring made of EPDM with KTW/W270 certification, upper part brass in accordance with DIN 50930-6, brass union nut, stainless steel spout

Item-No.:	Conneс.: 1/2"	Length:		Packing unit:
		L	H	
52024-Blau	1/2"	103	110	-/180
as above, but without stainless steel spout				
52024-B-OT	1/2"	103		-/180

Bib tap

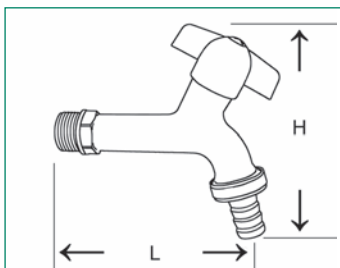

Valve body/handle made of PA6, RoHS- (Kat.2) / REACH-compliant, o-ring made of EPDM with KTW/W270 certification, upper part brass in accordance with DIN 50930-6, brass union nut, stainless steel spout

Item-No.:	Conneс.: 1/2"	Length:		Packing unit:
		L	H	
52024-Grün	1/2"	103	110	-/180
as above, but without stainless steel spout				
52024-G-OT	1/2"	103		-/180

Inner top part

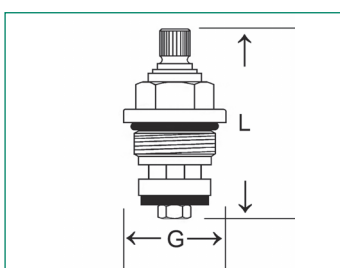

Forged brass, without grease chamber

Item-No.:	Conneс.: 1/2"	Thread:		Packing unit:
		L	G	
suitable for 52024				
52028 0		43	20	-/-

Brass quarter turn tap (market model)

With spacer and hose tail, optionally made of plastic or metal sheet, red painted steel lever, material: MS 58 hot pressed, nickel plated

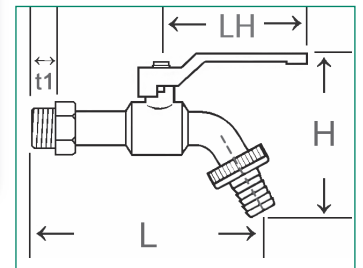
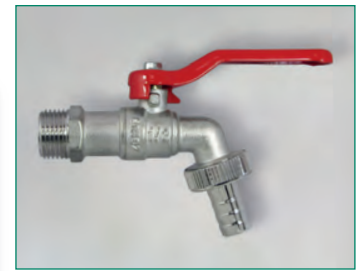

Item-No.:	Item-No.:	Item-No.:	Connection:	Thread length:	Length:	Height:	Length handle:	Pack. unit:
Spout Plastic red handle	Spout Plastic blue handle	Spout Metal sheet red handle		t1	L	H	LH	
53071 5	53071-Blau	53071-F	1/2"	13	112	54	77	6/ 90
53072 2	53072-Blau	53072-F	3/4"	13	120	58	77	5/ 75
53073 9		53073-F	1"	15	141	70	85	4/ 60
53077 7		53077-F	3/4" x 1/2" x 3/4"	13				6/120
53078 4		53078-F	3/4" x 3/4" x 1/2"	13			98	5/ 75

Brass quarter turn tap (market model)

Nickel-plated, with plastic hose tail, red painted steel lever

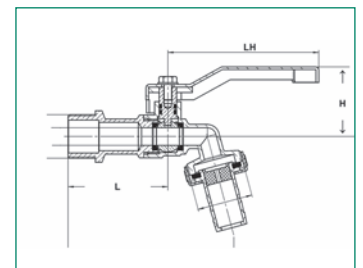

Item-No.:	Connection:	Thread-length:	Length:	Height:	Length handle:	Pack. unit:
		t1	L	H	LH	
53275 7	1/2"	-	45,5	31,7	75,5	10/100
53277 1	3/4"	-	45,5	33,1	75,5	-/

Brass quarter turn tap (market model)

Nickel-plated, with plastic hose tail, red painted aluminum T-handle

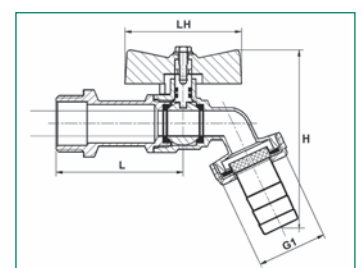

Item-No.:	Connection:	Thread-length:	Length:	Height:	Length handle:	Pack. unit:
		t1	L	H	LH	
53276 4	1/2"	-	75	77,5	44	12/120

Brass quarter turn tap (heavy version)



With spacer and metal sheet hose tail, aluminum lever with fixation (can be remounted, lockable), either red or blue, MS 58 hot pressed, nickel plated

Item-No.:	Item-No.:	Connection:	Thread-length:	Length:	Height:	Length handle:	Pack. unit:
Lever blue	Lever red		t1	L	H	LH	
53271 9	53271-R	1/2"	12	102	103	56	4/ 64
53272 6	53272-R	3/4"	12,5	121	104,5	56	6/ 48

Replacement handles heavy version:

53271-Griff	53271-R-Griff	1/2" + 3/4"				56	5/120
-------------	---------------	-------------	--	--	--	----	-------

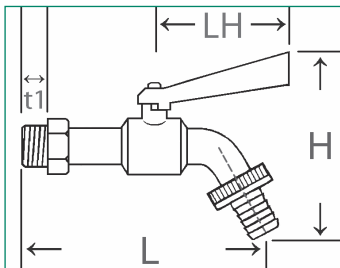

Brass ball valve, 90°



Pressed brass, chrome-plated, with straight spout, painted red steel lever

Item-No.:	Connect.:	Thread-length:	Length:	Height:	Length handle:	Packing unit:
		t1	L	H	LH	
53075 3	1/2"	11	65,5	59	77	5/60

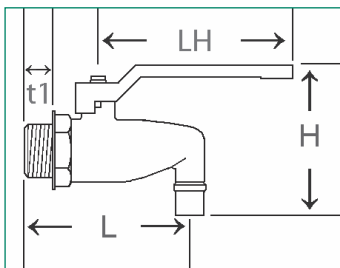

Brass quarter turn tap



With 2 lockable outlets, spacer, with hose tail (metal sheet), separately lockable, steel lever with red plastic coating

Item-No.:	Con.:		Thread-length:	Length:				Packing unit:
	Entrance	Leaving		t1	L	H	Leaving: LH	
53076 0	1/2"	3/4"		99,2	100	82	41	4/32
53079 1	3/4"	1"		110		82	41	-/-

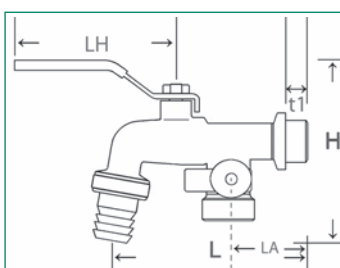

Brass quarter turn tap

With 2 lockable outlets, spacer, with plug-in connection system, separately lockable, steel lever with red plastic coating

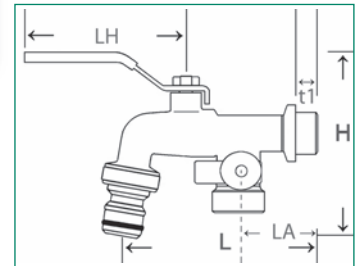

Item-No.:	Con.:		Thread-length: t1	Length:				Packing unit:
	Entrance	Leaving		L	H	LH	LA	
53076-S	1/2"	3/4"		99,2	100	82	41	4/32
53079-S	3/4"	1"		110		82	41	-/-

Brass drain valve, lockable

Lockable, nickel-plated, with plastic hose screw connection, red painted steel lever, **without lock**

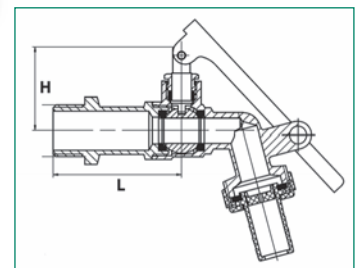

Item-No.:	Conne.:	Thread length: t1	Length:			Packing unit:
			L	H	LH	
53273 3	1/2"		52	34		6/90
53274 0	3/4"		61,5	34		5/75

Brass drain valve, lockable

Lockable, nickel-plated, with brass padlock, 2 keys, blue aluminium handle

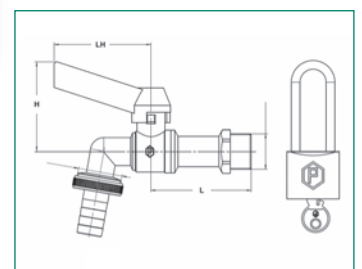

Item-No.:	Conne.:	Thread length: t1	Length:			Packing unit:
			L	H	LH	
53081 4	1/2"		57,5	51,3	55,5	1/64
53082 1	3/4"		64,5	52,3	55,5	1/48

Spare part padlock, brass body, steel lock shackle chrome-plated, 2 keys

53081-02	35 x 27 x 9,5 x 5,5 mm					
----------	------------------------	--	--	--	--	--

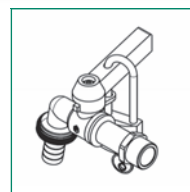

Brass quarter turn tap



Heavy version, self sealing, O-ring EPDM, hose tail made of sheet, steel lever in blue, wrench size 30

Item-No.:	Conne.:	Thread-length:	Length:			Packing unit:
		t1	L	H	LH	
53278-SD	3/4"	13	103	85	77	8/64

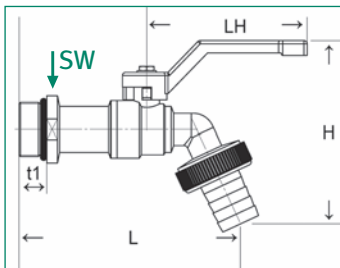

Stainless steel quarter turn tap



Water-carrying components AISI316 = 1.4401, stainless steel lever AISI304 = 1.4301 with blue plastic coating, lockable

Item-No.:	Conne.:	Thread-length:	Length:	Height:	Length handle:	Packing unit:
		t1	L	H	LH	
93071 3	1/2"	13	88	87	92	6/120
93072 0	3/4"	11	105	87	92	6/120
93073 7	1"	14	115	120	115	-/-

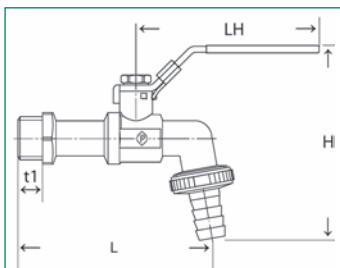

Polyamid ball valve



Lever red, with brass nut, hose tail made of stainless steel, PN 20

Item-No.:	Conne.:	Thread-length:	Length:	Height:	Length handle:	Packing unit:
		t1	L	H	LH	
53971-F	1/2"	15	116	97	75	6/72
53972-F	3/4"	15	116	97	75	6/90

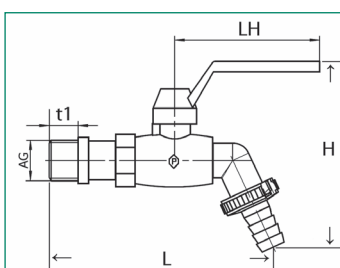

Polyamid ball valve

Lever blue, male thread made of brass, plug-in coupling made of plastic

Item-No.:	Connec.:	Thread-length:	Length:	Height:	Length handle:	Packing unit:
		t1	L	H	LH	
53975 6	1/2"	15	110	92	80	6/72

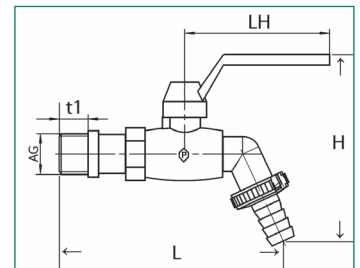

Multi-port ball valve, two-way valve

Brass nickel plated, straight, F/M, 2 x ball valve, separately lockable

Item-No.:	Connec.:	Durchgang:	Length:		Packing unit:
			L	H	
53304 4	3/4"	10 mm	110	89,5	6/36
53308 2	1"	14,5 mm	110	89,7	4/24

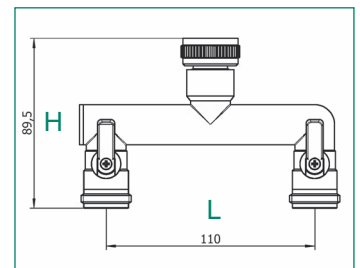
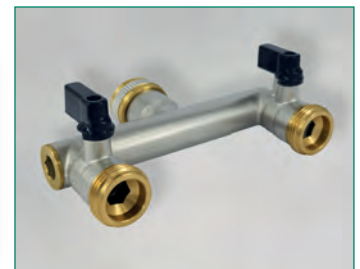

Multi-port ball valve, three-way valve

Brass nickel plated, straight, F/M, 3 x ball valve, separately lockable

Item-No.:	Connec.:	Durchgang:	Length:		Packing unit:
			L	H	
53305 1	3/4"	10 mm	110	89,5	3/18
53309 9	1"	14,5 mm	110	89,7	2/12

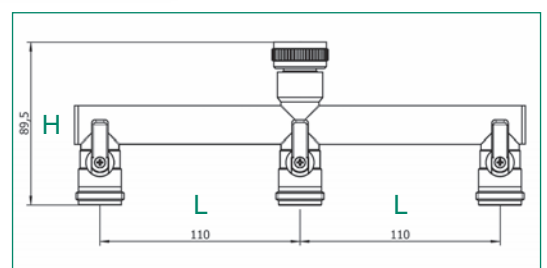

Brass valve for oily substances



Plain brass, lever sheet of metal

Item-No.:	Conne.: male	Departure:	Length:		Packing unit:
			L	H	
S-3315	G 3/4"	Ø 13 mm	70,4		6/72

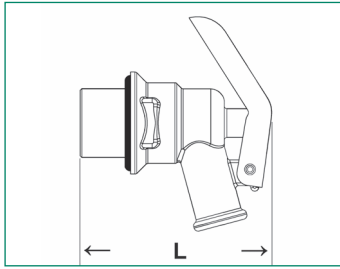

Tap for rain barrels



Brass plain/nickel plated, for brass bushing for rain barrels, with lock nut

Item-No.:	Item-No.:	Connection:	Length:	Wrench size:	Packing unit:
plain	nickel plated		L	SW	
52183-11156	52183-11156-cr	3/4" x 3/4"			6/48

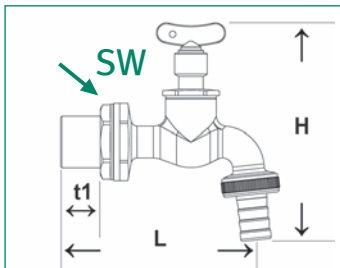

Brass bushing for rain barrels



Including nut and NBR-seal

Item-No.:	Connection:	Length: L	Wrench size:	Packing unit:
34901 0	M G 1/2" x G 3/8" nut F G 1/2"	24	24	10/250
34902 7	M G 3/4" x G 1/2" nut F G 3/4"	27	30	10/200
34903 4	M G 1" x G 3/4" nut F G 1"	32,5	37	10/100
34904 1	M G 1 1/4" x G 1" nut F G 1 1/4"	37	45	10/ 60

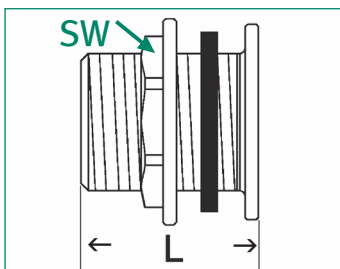

Brass angle bushing for tanks

Includes nut and NBR-seal

Item-No.:	Connection:	Spout:	Wrench size:	Packing unit:
S-385-11463-N	F 1" x M 1"	25 mm	38	5/40
Spare parts:				
S-385-Dichtung	34 x 50 x 3 mm			-/-
S-385-Körper	only body, M 1"	25 mm		5/40
S-385-Mutter	F 1", Ø55 x 10,5 mm		38	

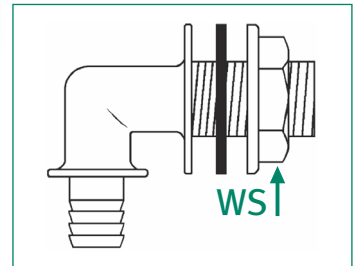

Brass angle bushing for tanks (market model)

Includes nut and NBR-seal

Item-No.:	Connection:	Spout:	Wrench size:	Packing unit:
S-3213	F 1" x M 1"	25 mm	37	5/40
Replacement seal:				
S-3222-1/2-D	33 x 29 x Ø11 mm			

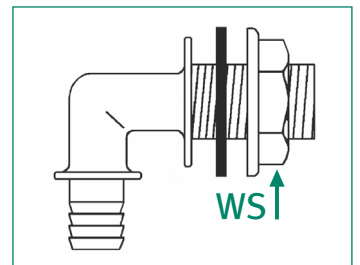

Brass barrel lid

Plain brass, S60 x 6 thread (F) and F (connection thread), with seal

Item-No.:	Connection:	Packing unit:
S-4143	3/4"	-/-

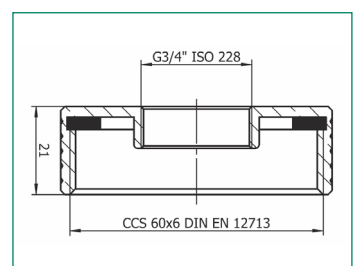
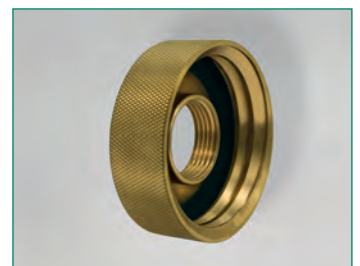

Brass barrel lid

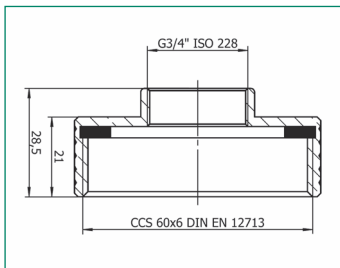
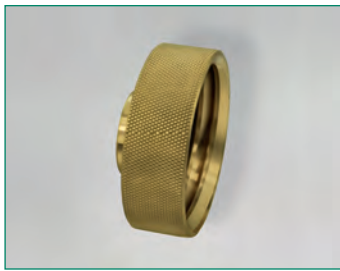

Plain brass, S 60 x 6 thread (F) and F turned inside out, with seal

Item-No.:	Connection:	Packing unit:
S-4159	3/4"	-/-

IBC-adapter

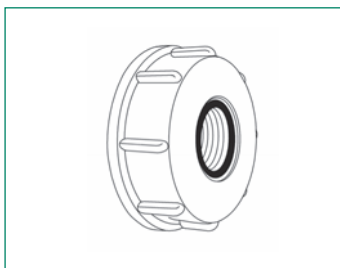

S 60 x 6 coarse thread (F) and F (connection thread), with O-ring, HDPE-plastic black, suitable only for service water

Item-No.:	Connection:	Packing unit:
92161 2	1/2"	25/400
92162 9	3/4"	25/400
92163 6	1"	25/400

IBC-adapter with quick coupling made of brass

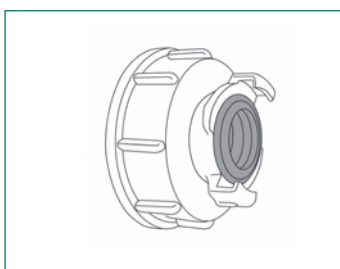

S 60 x 6 coarse thread (F) and F (connection thread), with O-ring, HDPE-plastic black, with quick coupling made of brass 3/4", cam width 40 mm, suitable only for service water

Item-No.:	Connection:	Packing unit:
92182 7	3/4"	25/200

IBC-adapter with ball outlet valve

S 60 x 6 coarse thread (F) and F (connection thread), with O-ring, HDPE-plastic black, with ball outlet valve, matt chrome plated, hose connector, red steel lever, suitable only for service water

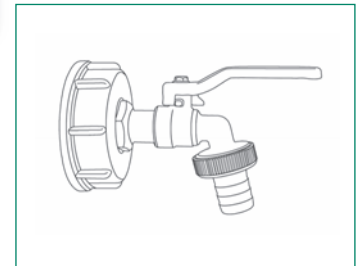

Item-No.:	Connection:	Packing unit:
92171 1	1/2"	10/120
92172 8	3/4"	10/ 80
92173 5	1"	5/ 40

IBC-adapter with lockable ball outlet valve

S 60 x 6 coarse thread (F) and F (connection thread), with O-ring, HDPE-plastic black, with lockable ball outlet valve, matt chrome plated, hose connector, red steel lever, without padlock, suitable only for service water

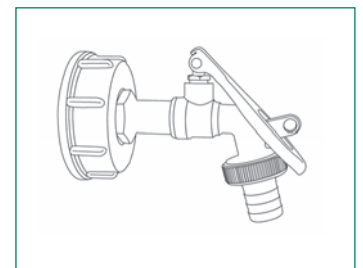

Item-No.:	Connection:	Packing unit:
92174 2	1/2"	10/80
92175 9	3/4"	10/60

IBC-adapter with double ball outlet valve

S 60 x 6 coarse thread (F) and F (connection thread), with O-ring, HDPE-plastic black, with double ball outlet valve, matt chrome plated, hose connector, red steel lever, mini valve with quick connector (plug in system), suitable only for service water

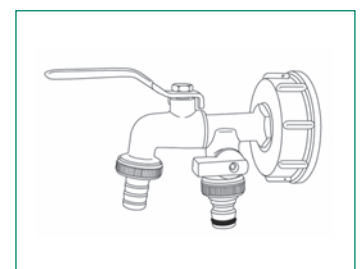

Item-No.:	Connection:	Packing unit:
92176 6	1/2"	5/50

IBC-adapter with ball valve and quick coupling made of brass



S60 x 6 coarse thread (F) and F (connection thread), with O-ring, HDPE-plastic black, with ball valve, M/M, red steel lever and quick coupling made of brass 3/4", cam width 40 mm, suitable only for service water

Item-No.:	Connection:	Packing unit:
92187 2	3/4"	5/40

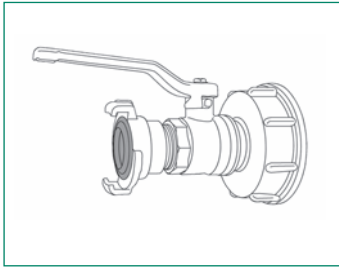

IBC-connection- set



For grazing troughs, with flexible armoured hose, length 750 mm, suitable only for service water

Item-No.:	Connection:	Packing unit:
92192 6	3/4"	-/-

puteus GmbH terms and conditions for contracting, delivery, and payment

Section 1 General

1. These general conditions of sale apply to all present and future business relations with companies, legal persons governed by public law, and separate estates under public law with respect to deliveries and other services including work orders and the delivery of non-fungible items.
2. The buyer's purchasing terms will not be recognized even if puteus GmbH does not explicitly object to them upon becoming aware of them or after receipt unless puteus GmbH explicitly approves of their validity in writing.

Section 2 Offerings

1. Offerings from puteus GmbH are non-binding and subject to availability.
2. The right to make reasonable technical changes in the form, color, and/or weight of offerings is reserved.

Section 3 Shipping

1. Shipping, including free delivery, is at the buyer's own risk. Selection of the routing is hereby ceded to puteus GmbH. The buyer will bear the shipping costs unless an agreement to the contrary has been made in writing.
2. Transportation insurance will only be obtained upon written request by the buyer and at the buyer's expense. Any damages incurred in transit are to be immediately reported to the carrier and to puteus GmbH.
3. If items should be delivered in returnable containers, then the containers are to be emptied of residues upon receipt and promptly returned carriage paid. Loss or damage of re-use packaging will be at the buyer's expense if the buyer is responsible.
4. Non-returnable packaging will not be accepted by puteus GmbH and must be disposed of by the customer and the customer's expense.
5. Returnable containers that are not explicitly included in the price or the invoice amount will only be made available on loan. They will remain the property of puteus GmbH.

Section 4 Passage of risk

The risk of accidental loss or accidental impairment of products will pass to the buyer upon delivery or, in the event of sale by dispatch, with the handing over of the item to the shipper, carrier, or other person or institution designated to execute the act of shipping.

Section 5 Delivery/acceptance

1. Delivery periods are approximate. They are subject to timely receipt of supplies. If puteus GmbH does not adhere to agreed delivery periods, then the buyer is to set an appropriate subsequent delivery period of at least three weeks for puteus GmbH in writing starting upon receipt of the new deadline by puteus GmbH. The buyer will be entitled to withdraw upon expiration of the subsequent deadline. puteus GmbH will be authorized to make subsequent delivery until a written declaration of withdrawal has been received.
2. In the event of force majeure, industrial action, or other faultless stoppages that last longer than one week, the delivery or acceptance period will be extended by the duration of the hindrance up to a maximum of five weeks in addition to a subsequent-delivery period. The extension will only come into effect if the reason for the hindrance is promptly reported to the other party as soon as it has been observed that the aforementioned period cannot be complied with.
3. Partial deliveries are permissible.
4. In the event that the buyer should default in taking delivery, puteus GmbH will be authorized, after setting a five-day grace period, to invoice the buyer as of the time that the product was provided or to withdraw from the agreement or to demand compensation for damages at its own discretion. Storage of products that are not accepted by the buyer will be at the buyer's own risk and will take storage costs into account.

Section 6 Sample materials

1. Samples will be delivered at cost. In the absence of any agreement to the contrary, samples that have been loaned to the buyer by puteus GmbH will remain our property.
2. In consideration of technical or material-dependent deviations in production, samples are not considered samples in the meaning of Section 454 of the German Civil Code (BGB).

Section 7 Prices

1. puteus GmbH prices are net prices and do not include statutory value-added tax.
2. If there should be a period of more than four months between the conclusion of the agreement and delivery, then the puteus GmbH prices as of the day of delivery will apply. This will not apply if delivery has been delayed due to the fault of puteus GmbH.

Section 8 Payment

1. puteus GmbH invoices will be issued on the day of delivery or provision of the product. Payment will be due in full within 30 days of the invoice date. In the event of payment within eight days of the invoice date, puteus GmbH will grant a cash discount of 2% of the remaining invoice amount after any trade discounts have been deducted.
2. Upon payment after the due date, puteus GmbH will calculate an interest rate of an additional 8% above the base rate. Both puteus GmbH and the buyer will be at liberty to present evidence of greater or lesser damage.
3. The credit balance may only be adjusted based on claims that are uncontested or that have been determined without further legal recourse. The same applies to withholding due invoice amounts unless the counterclaim is based on the same statutory relationship.

4. puteus GmbH will not be obligated to make further deliveries on the basis of any current contracts until due invoice amounts have been paid in full, including interest. If after a contract has been concluded it should become apparent that puteus GmbH's pecuniary claim is in jeopardy due to the buyer's insolvency or if the buyer should be in default on a significant payment amount or if other circumstances should arise indicating that the buyer's solvency has significantly deteriorated, then the rights according to Section 321 of the German Civil Code (BGB) will accrue to puteus GmbH. puteus GmbH will then also be authorized to accelerate all claims that are not yet due based on the current business relationship with the buyer

5. The supplier is entitled to assign his receivables against buyers to a third party.
6. The buyer is obliged to reimburse any fees, costs and expenses in connection with any successful legal prosecution against him outside Germany.

Section 9 Liability for defects

1. Obvious defects or other objections with respect to the delivery item – including the absence of guaranteed or warranted qualities – are to be promptly reported to puteus GmbH in writing no later than 14 days after receipt of the delivery item.
2. puteus GmbH assumes no liability for deviations in quality, color, size, (specific) weight, or equipment that might arise in the course of normal business practice, are minimal, or are unavoidable. Application-specific verbal and written consultation from puteus GmbH – including from puteus GmbH's vendors – will not exempt the buyer from responsibility to examine delivered products for their intended purpose.
3. No objections to obvious defects will be accepted after the product has begun to be processed.
4. Upon receipt of valid notice of defect within the prescribed time limit, puteus GmbH may choose to eliminate the defect or deliver a non-defective product (supplementary performance) at its own discretion. In the event that puteus GmbH should fail or refuse to execute supplementary performance, the buyer may withdraw from the agreement or reduce the purchase price after an appropriate period has unsuccessfully elapsed. If the defect is insignificant or if the product has already been sold, processed, or altered, then the buyer will only be entitled to a reduction of payment.

Section 10 General limitation of liability, statute of limitations, and right of recourse

1. puteus GmbH, including its management and other auxiliary persons, will be liable for violations of contractual or non-contractual obligations, particularly due to impossibility, delay, fault in preparing the contract, or tort, only in the event of wrongful intent or gross negligence and only with respect to damages that are typical of the contract and that are foreseeable at the time that the contract is concluded. For the remainder, liability on the part of puteus GmbH is also excluded for damages caused by defects and consequential damages.
2. These restrictions will not apply to culpable violation of essential contractual obligations that jeopardize the purpose of the contract; in the event of culpably induced harm to life, body, or health; if and to the extent that puteus GmbH has guaranteed the state of the purchased item or has assumed a procurement risk; nor in cases of compulsory liability according to the German Product Liability Law. This will have no effect on regulations concerning the burden of proof.
3. In the absence of any agreement to the contrary, the statutory limit on contractual claims against puteus GmbH that accrue to the buyer by reason of and in connection with product delivery will be one year after delivery of the product. This term will not apply to products that are used for a construction in a manner that is in keeping with their conventional use. This will have no effect on puteus GmbH's liability arising from intentional or grossly negligent breaches of obligation or culpably induced harm to life, body, or health.
4. The buyer's right of recovery in accordance with Section 478 of the German Civil Code (BGB) against puteus GmbH is restricted to the statutory scope of warranty claims that are invoked against the buyer by a third party and assumes that the buyer has fulfilled its obligation to puteus GmbH to give notice of defects in accordance with Section 377 of the BGB.

Section 11 Reservation of ownership

1. Delivered products will remain the property of puteus GmbH until all claims as of the moment that the contract was concluded have been paid in full regardless of the legal basis for the claims. This will apply even if payments for particularly specified claims have been made. Neither the suspension of individual claims in a current account nor the balancing of accounts and acknowledgment thereof will affect the reservation of ownership.
2. If the reserved product that was delivered to the buyer should be machined or processed by the buyer, the machining or processing by the buyer will be executed by the buyer for puteus GmbH without any obligations accruing to puteus GmbH. If the delivery item is connected to, mixed with, or combined with items that do not belong to puteus GmbH, then puteus GmbH will be come the co-owner of the total item in accordance with statutory provisions. If the buyer should acquire sole ownership of the new item, then it hereby transfers co-ownership of the items connected to it to puteus GmbH in proportion to the value of the delivery item at the time that the connection was made.
3. If the buyer should sell the reserved product individually or in conjunction with a product that does not belong to puteus GmbH, then the buyer hereby assigns the claims resulting from the resale to puteus GmbH in the amount of the value of the reserved product with all ancillary rights and claims that accrue in lieu of the reserved product. If the resold product is co-owned by

puteus GmbH, then the claim assignment will extend to the amount that corresponds to puteus GmbH's share of the co-ownership. puteus GmbH hereby accepts these assignments. Incorporation of the reserved product into built structures will also be considered a sale.

4. The buyer is hereby authorized to collect on claims arising from resale. This collection authorization will become void if it should be revoked by puteus GmbH no later than the moment of a default on payment, non-payment of a bill, or petitioning for the initiation of bankruptcy proceedings. puteus GmbH will only invoke its right to revocation if, after the conclusion of the agreement, it becomes apparent that puteus GmbH's pecuniary claim arising from this or from another agreement with the buyer is in jeopardy due to the buyer's insolvency. Upon request by puteus GmbH, the buyer will be obligated to immediately inform its own buyer of the assignment to puteus GmbH and to promptly transfer to puteus GmbH the documents necessary for collection, in particular the buyer must transfer to puteus GmbH a precise summary of its claims with the name and mailing address of its own buyer and must provide puteus GmbH with all the information necessary to assert the assigned claims. The buyer hereby authorizes puteus GmbH to inform the secondary buyer of the assignment and to collect on the claims immediately upon default on a payment or deterioration of its financial circumstances. puteus GmbH will have the right to demand that the legal validity of the assigned claims be examined by a representative based on the buyer's accounting. The buyer must provide puteus GmbH with a summary of the reserved products that are still on hand.
5. If the buyer should act in breach of contract, and particularly in the event of a default on payment, puteus GmbH will be authorized to withdraw the delivery item after giving formal notice and setting a time limit and the buyer will be obligated to return it. Neither assertion of the reservation of ownership nor seizure of the delivery item by puteus GmbH will be considered withdrawal from the agreement.
6. The buyer is hereby authorized and empowered to resell, use, or incorporate the reserved product only in the conventional and proper course of business and only on the understanding that claims that have been assigned in accordance with the provisions above will in fact proceed to puteus GmbH. The buyer is not authorized to otherwise transfer the reserved product. The buyer may not pledge the reserved product nor transfer ownership as collateral. The buyer's authorization in accordance with the first sentence of this paragraph will not apply in the event of impending or already established insolvency or in the event of other essential deterioration of its financial circumstances.
7. The buyer must both promptly inform puteus GmbH of enforcement measures undertaken by third parties with respect to the delivery item with reserved ownership or the claims assigned to us and deliver the documents necessary to challenge the enforcement.
8. If the value of the total collateral granted to puteus GmbH should exceed puteus GmbH's claims by more than 20%, then puteus GmbH will be obligated and prepared to return or release to the buyer the collateral granted to puteus GmbH to the extent that it exceeds the agreed coverage limit.

Section 12 Blanket orders and call orders

1. If an on-call purchase is agreed with the buyer, then payment for outstanding deliveries will be due automatically upon expiry of the on-call term. The buyer will then be obligated to call for the outstanding deliveries and to pay the agreed purchase price as paid for the transfer of the property. With respect to any individual installment, in addition to fulfillment, puteus GmbH will have the right to demand compensation for pecuniary detriment or to proceed in accordance with Section 323 of the German Civil Code (BGB).

2. If the buyer should fail to call for the agreed deliveries within the agreed on-call term, then puteus GmbH will have the right to otherwise utilize the products without fixing a time limit. The same will apply if the buyer should file for bankruptcy within the on-call term and/or become insolvent.

Section 13 Price clause

puteus GmbH hereby reserves the right to reasonably change its prices for all orders – including on-call orders and call-off contracts – that, either contractually or at the buyer's request, are delivered more than three months after the order was placed if costs should decline or increase after the contract was concluded, particularly due to wage increases or changes in the cost of materials. The orderer will be provided with evidence of such changes upon request.

Section 14 Proprietary rights, tools, models, and illustrations

1. If items are delivered based on illustrations or other details provided by the buyer, then it will be the buyer's responsibility to ensure their accuracy and that no third party proprietary rights are violated. The buyer must indemnify puteus GmbH against any claims by a holder of proprietary rights.
2. puteus GmbH may invoice for molds, models, tools, and equipment that are required for the ordered product. They will remain property of puteus GmbH even if puteus GmbH manufactured them on behalf of the buyer and/or has paid the buyer in whole or in part. This will apply even if they were manufactured according to special instructions from the buyer, which uses them exclusively for deliveries to the orderer, as long as it fulfills its commitment and payment obligations and the business relationship persists.
3. If no parts are reordered two years after the last production, then puteus GmbH, after giving appropriate notice to the buyer and after a period of six weeks from receipt of notice by the buyer, will have the right to scrap or otherwise utilize the molds, models, tools, and manufactured equipment.
4. If the buyer should file for bankruptcy, puteus GmbH will be authorized to scrap or otherwise utilize the molds, models, tools, or manufactured equipment before two years have expired and without notifying the buyer in advance.

Section 15 Return of catalog products

Catalog products may only be returned due to product redelivery according to prior agreement and are to be undertaken freely. 30% of the handling costs will be deducted from any credit entries for re-saleable products.

Section 16 Place of fulfillment/legal venue

1. The place of fulfillment for all claims arising from the contractual relationship will be puteus GmbH's principle place of business.
2. For all present and future claims arising from the business relationship, including bills and checks receivable, the legal venue will be puteus GmbH's corporate headquarters. This will apply even if the buyer has no legal venue in Germany or if the buyer's domicile or usual residence is unknown at the time when proceedings are instituted. puteus GmbH will also be authorized to bring an action at the buyer's principle place of business.
3. The laws of the Federal Republic of Germany will apply. The terms of the United Nations Convention on Contracts for the International Sale of Goods will not apply.
4. If particular terms of the agreement with the client, including these General Terms and Conditions, should be or become legally inoperable in whole or in part, the validity of the remaining terms will be wholly or partially unaffected. The wholly or partially inoperable provision will be replaced by a provision whose commercial outcome approximates that of the inoperable term as closely as possible.

puteus GmbH, Lenenweg 6, D-47918 Tönisvorst
Version: November 2023

TECHNICAL INFORMATION

Size and weight

Unless otherwise stated, all dimensions are in millimeters (mm) and weights are in grams (g).

PN = nominal pressure in bars 1 bar 10N / cm² ⇒ ca. 10 m column of water

DN = nominal diameter in inches or mm 1" = 25,4 mm ⇒ ca. 25 mm

Nominal pressure is the maximum applicable pressure at the standard temperature, which, unless otherwise stated, is 20°C.

Nominal diameter is the excess pressure when all operational conditions are taken into consideration, including pressure surges. It depends on the operating temperature, the medium, the size of the component/valve, and, where applicable, the type of seal.

There are legal provisions or regulations that apply to certain areas of application and that take precedence over the guidelines provided in this catalog.

Medium

The details presented in this catalog with respect to pressure and temperature conditions refer to water.

Suitability for gases, oils, or glycolic or other media should be investigated in light of the operating pressure and operating temperature. Our applicability information may not be applied to media or operating conditions other than those that have been approved without our clearance.

Custom models

If there are no articles in our standard program that are suitable for your needs, we can also create custom models upon request. For this, we would need a detailed letter of inquiry with the corresponding number of units as well as drawings or sample parts.

Installation instructions

A) Screw thread

Connection dimensions and screw thread of complementary proportions must always be selected.

The screw thread should not be too strongly sealed with hemp or sealing tape, which is to say that after the hemp has been applied, the crest of the thread must still be visible. Sealing the thread too strongly will increase the pressure in the component. Over time, that pressure can cause cracks.

To avoid causing damage during installation, the components should be conventionally screwed in with the appropriate, customary tools, without excessive force and without lever extension.

Self-sealing valves must not be sealed further with hemp or sealing tape. The corresponding mating thread must be of sufficient length (min. 12 mm). Where applicable, components are only to be installed on the spanner flats provided for that purpose by means of a suitable spanner/pliers. Our products must be installed without tension in due consideration for the information above. Alignment, e.g., of connections that we provide by means of heating appliances, is prohibited because this can also cause tension cracks and secondary damage later on.

Where applicable, connecting different metals or alloys can cause corrosion, for which puteus GmbH cannot be held liable (e.g., connections between brass and stainless steel or copper with zinc-plated metals). These characteristics are to be checked before our products are installed.

The components' pressure and sealing are to be carefully tested after installation. Where applicable, the installation instructions that are enclosed with the components are to be observed when doing so.

B) Gate valve

After disassembly/repairs/maintenance work, the upper section is only to be reassembled with a raised sealing wedge. Do not damage sealing surfaces/key seats. Sealing wedges cannot be replaced.

C) Socket slide valve

These must only be installed in closed position. Key seats must not be damaged by screwing in pipes by force.

D) Ball valves

To ensure operability, for example, only set ball valves on very low static and dynamic power. Where applicable, the component should be supported by appropriate measures (e.g., pipe clamps or similar). The torque to be applied to the ball valve must only be applied to the spanner flats at the end that is being screwed in, otherwise there is a risk that the ball valve could be unsealed or cracked. Likewise, bodies and ball valve screwing components must not be screwed against one another. Doing so would also cause leaks and/or the risk of breakage.

E) Pipe and hose connections

According to DIN EN 1717 pipe and hose connections for devices that contain non-potable water (e.g. washing machines) must be connected to a water intake using a backflow preventer to avoid any backflow of polluted water into the potable water line.

Recommendations for the use of ball valves

1. General information

Ball valves serve as shut-off valves for pressurized media. The manufacturer's information on flow media, operating pressure and temperature range must be respected. Using other than approved media may shorten the ball valve's lifespan or lead to a failure of the ball valve.

The installation may only be carried out in systems with equal pressures. Any possible pressure surges due to the quick-lock system must be taken into account as these may damage the piping system. The valve can be opened and closed by a 90° turn of the lever, intermediate positions of the lever are not allowed during the operating condition.

Ball valves should be stored in a dry place, free of dirt and without direct sunlight.

2. Installation and removal instructions

Ball valves may only be used in compliance with the requirements for their intended use. The installation must be carried out stress-free and with appropriate tools in a pressure less state only by qualified and trained staff. Do not turn the ball valve forcibly and do not use it to align the pipeline. The ball valve must be checked for damage before installation. Plumbing lines must be rinsed before first commissioning after maintenance and repairs.

Do not clamp the ball valve too tightly in a vise or something similar for pre-assembly in order to avoid damage and stress cracks on the body. According to the general installation instructions you must not seal the threads with too much hemp. The tips of the threads must remain visible. When installing the ball valve only use the designated spanner flat at the installation side to apply the counter-torque. Never apply the wrench to the body or to the side opposite of the installation side. Do not exceed the recommended tightening torque, any existing sensor plugs must be tightened to 15 Nm. The handle must not be used as a mounting lever.

The use of quarter-turn ball taps is only allowed with free outflow to avoid a backflow of sewage into the pipeline. Quarter-turn ball taps are not suitable for the use in domestic water-pipe systems or as device connection taps. It is necessary to carry out functional and leak tests after installing and before the ball valve is put into operation for the first time.

3. Commissioning

Operating conditions and installation works must be checked again before commissioning. Notice: Due to a long-term storage or long downtimes the release torque may be much higher than the usual turning moment.

Before initial start-up or putting into operation after maintenance work the pipeline has to be deaerated. In case of pressure surges air bubbles may cause explosions or damages to the piping system. Therefore the pressure should only be slowly increased.

Ball valves at the end of a pipeline must be sealed professionally with a blind flange to avoid the valve being forcibly torn off. Caution! Danger!

The ball valve may not be operated with a tool that shall serve to increase the leverage (e.g. hammer, pliers, extension tubes etc.)

4. Maintenance and inspection

Depending on the assembly situation, ball valves have to be drained before the first frost sets in as well as before cleaning works. When emptying the valve the handle should be in a 45-degree-position to make sure that the dead space may be emptied, too. Tests for tightness, functionality and damages should be carried out regularly. Depending on the operating situation this should be done in shorter time intervals. During long periods of disuse the ball valve should be put into operation every few months to guarantee proper functioning.

Defective or corroded valves or valves that do not work properly must be replaced during maintenance work. Replacement and removal may only be carried out by qualified personnel whilst the pipeline is not under pressure.

5. Warnings

The manufacturer will not accept any liability for deficiencies caused by assembly errors, improper handling, the use of impermissible media or not allowed operating situations as well as for damages due to normal wear and tear.

Ball valves may not be used as throttle valves! They may only be used in a fully opened or closed situation to avoid damages to seals in the spherical area. Depending on the operating situation the ball valve's body can get very warm. Caution!

Legal health and safety regulations, national rules and technical rules and standards for certain operating and mounting situations have to be observed. Viscous fluids or hardenable media as well as certain chemical substances may impede the function or make it impossible. Please refer to the manufacturer's information.

Polluted or sandy media may cause damages to the seals. In case of neglecting the given information on working pressure or working temperature leaks may occur or the ball valve may tear apart. Caution!

(as of November 2023)

Further Information:

Unless otherwise indicated or unless they are provided with drain plugs that are used to empty the valve before the frost season, no valves (taps, check valves, foot valves, gate valves, ball valves, etc.) are frost-resistant.

Our ball valves, valves and fittings have to be installed without mechanical tension. They must not be used for adjusting pipings.

Chrome plated surfaces, e.g., on bathroom fixtures or device connector valves, are sensitive to lime-dissolving agents, acidic cleaners, and all types of

abrasives. These surfaces must only be cleaned with clear water and a soft cloth (leather).

Our pumps, wall and standing fountains are provided with a protective coating for transport purposes by the manufacturer. This first layer of paint is not considered to be a permanent corrosion protection or optical coating.

We offer no guarantee for wearing parts in the event of corrosion or malfunction due to very hard water or contaminated water lines (e.g., with respect to sealing or mixing jets) or due to improper assembly; chemical or mechanical events during transportation, storage, connection, repair, or use; or improper handling of products.

We provide the statutory guarantee for defects in our products that arise due to material or manufacturing defects or through normal use. Defects due to non-observance of the information above are excluded from that guarantee.

Previous documents cease to be valid upon publication of the catalog. Our catalog serves exclusively as a basis for wholesale, industrial, and technical information and work. It is not a sales document.

Returns are only permitted based on prior written agreement; this particularly applies to custom production. Return deliveries that are not prepaid will not be accepted.

Recommendations for the handling of hoses

A number of factors can have an impact on how long the hose lasts:

- application
- medium
- abrasion
- storage etc.

Therefore it is not possible to give a general information about the durability of a hose. The end user should regularly check the hose for leaks and replace it if necessary.

The rubber compound can change its characteristics over time because of its chemical properties. This process can be accelerated by improper use of the hose or other influences. Therefore we give the following recommendations:

Storage

1. Avoid long storage periods! Otherwise, a check is important at the 1st use.
2. Ideally you should store the hose at a temperature between +10°C and +25°C. Temperatures of less than 0°C or more than +40°C will damage the hose. Keep the hose away from all sources of heat! Avoid dry air as well as high air humidity!
3. No direct solar radiation or aggressive artificial light!
4. Airflow and ozone can ruin the material. Do not store near electric motors, high-voltage units etc. because of the danger of sparks or electrostatic charge or uncontrolled heating of eventually mounted metal couplings.
5. Different substances can affect the material of the hose. Therefore please avoid any contacts with: solvents, fuels, acids, disinfectants, wood preservers, volatile or organic chemical substances or mixtures. Manganese, iron, copper and copper alloys may affect some kinds of rubber mixtures.
6. Store loosely rolled and stress-free to avoid compressing the tube. Coiled hose should be stored in a horizontal position. Do not pile up and pay attention to the weight to avoid any deformations! If given by the supplier, please note the minimum bend radii to prevent kinks.
7. Check the hose for suitability and proper seat of mounted couplings before delivery or resale.
8. Clean the hose before re-storage (please check suitability of the cleaning agent !). This applies particularly in case of the use of chemical, explosive or abrasive materials. Checks for reusability are essential.

Use

1. Hoses should only be used in accordance to their intended purpose. The misuse –e.g. as towing rope- is not allowed.
2. Before using the hose you have to check its suitability with regard to its characteristics, type or size.
3. Exercise due diligence when transporting the hose. The hose may not be exposed to severe shocks or tensile forces across rough surfaces. Avoid twisting, kinks and knots.
4. Please note the mentioned operating pressures! If checking the hose for leaks, the pressure in a hose free of air bubbles must only be increased gradually until the maximum pressure is reached.
5. The hose has been developed to channel liquids which are approved by the manufacturer. This does not give the permission to immerse the hose in the liquids.
6. Please note the ambient temperature and the maximum operating temperature which depend on the medium. Keep hose line away from sources of heat!
7. The material of the hose must be resistant to all media used. Check this before use. Changes in the concentration of media, period of use or temperature may cause changes in the suitability and chemical resistance of the hose.
8. Varying degrees of abrasion may occur depending on the kind of medium used or pulling the hose across different surfaces. Therefore you have to control the wear and tear of the tube regularly.
9. Make sure that installed hoses and hose connections are protected against impurities to avoid a contamination of hose and medium; particularly when used with drinking water.
10. Do not install hose lines on driveways or rather protect them against running over. If necessary, use hose bridges or the like.
11. Mounted hose fittings or spray nozzles should not be used as end or shut-off valves as they are not constructed for that purpose. Do not expose them to a permanent water pressure to prevent the valve/nozzles from being torn off and/or avoid bursting of the hose. After finishing work the water supply to the hose has to be shut off.

Assembly and commissioning of hose lines in technical fields

Please note:

1. When using hoses fitted with connectors, ensure that they are the correct length. An extension through the use of several connecting hoses is not permissible.
2. Before putting a hose line into operation please check if it is in accordance with eligible regulations and directives, e.g. the instructions of the Trade Association To02, §§14 and 15; the Industrial Safety Regulation (BetrSichV) or the Technical Rules for operating safety (TRBS).
3. Do not use a hose line if there are any visible damages!
4. Hose lines with given inspection intervals may not be used when the inspection date has expired. After repair or modification the hose line must be checked.
5. The hose line must be cleaned before putting it into operation. Do not forget to check the suitability of the cleaning agent!
6. With regard to electrostatic discharge the following instructions have to be observed: TRBS 2153 (“Avoiding of ignition hazards due to electrostatic charges”)
7. The hose line must be cleaned when changing from one to another flow medium to avoid a possible chemical reaction or contamination of the new medium.
8. For special applications or construction projects, it is essential to comply with the manufacturer's instructions.

Disposal

Please follow local regulations if you want to dispose hose materials and/or hose fittings.

Legal information: According to the Drinking Water Ordinance [esp. §§ 3 and 17], every tapping point of water that is not intended for human use must be permanently marked with a notice "no drinking water" and safeguarded against inappropriate use!

Tapping systems for non-drinking water that are installed in the household in addition to the drinking water supply system must be reported to the health authority!

Specifications and illustrations as well as descriptions and packing units are non-binding. They are purely informational and no legal obligation may be derived from them.

We reserve the right to make technical and formal changes in the interest of further technical development or that are necessary for financial reasons. Alterations and additions are made continuously.

We assume no liability for any printing errors or divergent illustrations. In the event of erroneous size information, the figures at the start of printing will no longer apply.

Conversion table inch/millimetre

inch fractional value	mm metric	inch fractional value	mm metric
1/8"	3,175 mm	1 3/4"	44,450 mm
1/4"	6,350 mm	2"	50,800 mm
3/8"	9,525 mm	2 1/4"	57,150 mm
1/2"	12,700 mm	2 1/2"	63,500 mm
5/8"	15,875 mm	2 3/4"	69,850 mm
3/4"	19,050 mm	3"	76,200 mm
7/8"	22,225 mm	3 1/4"	82,550 mm
1"	25,400 mm	3 1/2"	88,900 mm
1 1/4"	31,750 mm	3 3/4"	95,250 mm
1 1/2"	38,100 mm	4"	101,600 mm



We keep an eye on our qualities:

Both our quality and environmental management system have been certified on the standard basis DIN EN 9001 (Nov. 2015) and DIN EN 14001 (Nov. 2015). We face the challenge to guarantee highest qualities for our products and services. All raw materials and external products are checked for quality and suitability. Our own products are tested on a random basis during the production processes, final leaking and material tests are performed.

Our products meet several requirements, such as DVGW, SVGW, KTW, noise class tests (PA-Nr.), ACS and are also complying with binding DIN standards in respect to dimensions or noise behaviour.

With regard to the brass alloy **puteus** valves, fittings and the seals we use are in full compliance with the amended requirements of the drinking water ordinance. Long before the reference date in April 2017 we made sure that the regulations of the valuation basis of the Federal Environmental Agency (UBA) were implemented. These regulations apply to metallic materials which may get in contact with drinking water. They also include the list of materials that are in accordance with the drinking water hygiene (known as the "UBA Positive List"). On the basis of these standards our quality management has also been certified for the process to comply with the nickel values for valves, fittings and other components in drinking water under the terms of the drinking water regulations and recommendations of the Federal Environmental Agency.

Therefore we can ensure a high product quality for our customers because of our high quality awareness.

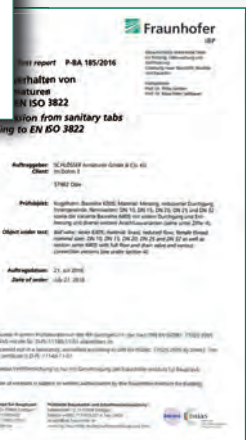

Disclaimer:

puteus GmbH | Lenenweg 6 | 47918 Tönisvorst
 Domizil Tönisvorst | AG Krefeld | HRB 9505 | UST-IDNR. DE 120 581 001 | ILN 40 12167 00000 3
 CEO: Hans de Gruyter | Peter de Gruyter

© 2023

Our packaging and labelling proposals

Four-colour cartons – version 1 –

with Euro-standard-holes, colour prints and product descriptions on the front-side, pictographs and installation dimensions on the back, top and bottom. Items that are available in carton packaging can be found in our catalogue. The item numbers are marked with an additional “-K”.



Four-colour cartons – version 2 –

Promotional four-colour cartons with product photos and descriptions.



Labels with EAN-barcodes

Nearly all articles can be labelled with EAN-codes. The self-adhesive and tear-resistant labels contain a product description, barcode and EAN-code.

The complete EAN-code consists of:

4012167 + item-no. + verification digit
(without “-E” or other extensions).



Self-service cards

These cards can be used for certain products of the irrigation sector. The cards are printed with article descriptions, sizes and EAN-codes.



Polybags

We offer customized polybags for single products. Each polybag can be printed according to your wishes.



Note: All information is subject to possible printing errors or changes in design or construction. Reprinting and photomechanical reproduction- also including excerpts - only with the authorization of puteus GmbH, Lenenweg 6, D-47918 Tönisvorst.



Other catalogs to our range:



1 Appliance connection fittings



2 Sanitary fittings, kitchen + bathroom



3 Garden hose fittings + valves



4 Fittings



5 Ball valves + heating valves



6 Hand pumps, hose + accessories



Eine starke Gruppe

puteus GmbH

Lenenweg 6 · D-47918 Tönisvorst

Tel.: +49 2151 9952-0

Fax: +49 2151 9952-99

E-mail: info@puteus.de · www.puteus.de